

DX164-W

The DX164-W is a fixed installation I/O Expander for the Allen & Heath dLive, Avantis, AHM-64 and SQ digital mixing systems. It provides 16 remote controlled mic/line preamps and 4 XLR line outputs. It connects to the mixer over a single Cat5 cable.

A second DX164-W or a DX168 can be connected when running in Cascade mode. Alternatively, a redundant connection can be made to compatible hardware.

The DX164-W can be operated freestanding, mounted in a floor pocket, mounted on a wall, or flush mounted in a wall. Different power options are provided to suit the application.

⚠ This product must be installed by a professional installer or qualified electrician.

Contents

Check that you have received the following with your DX164-W unit:

- Optional gland module (part number 004-1097) for permanent AC mains wiring installation.
- Mounting frame (AH11504) for in-wall or wall surface mounting.
- 6x M4 6mm T20 screws (AB2921) for mounting the DX164-W to the mounting frame.

Connection



Redundant mode – to compatible hardware only



Cascade mode – add second DX164-W or DX168

Top panel and power options

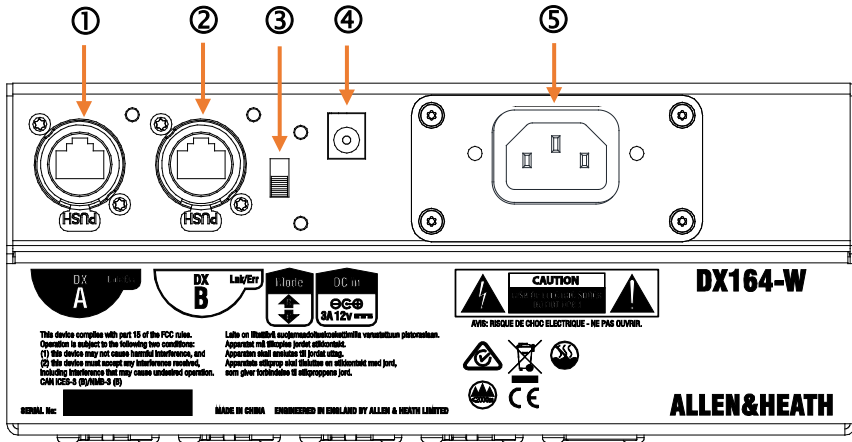

① **DX A** EtherCon port for connection to the mixing system. The cable carries the audio signals as well as preamp control and system status data.

ⓘ DX164-W requires dLive firmware V1.7 or higher / SQ firmware V1.3 or higher.

② **DX B** EtherCon port for daisy chaining of a second unit or cable redundancy.

③ **DX B mode switch** Switch to **Redundant** for 2 cable connection to compatible hardware e.g. dLive S Class or DX Link card. Switch to **Cascade** for connection to a second DX164-W or DX168 unit.

④ **DC 12V Input** Can be used instead of AC mains to power the unit where adequate DC distribution is provided in a building. Can also be used as a backup power supply in case of mains failure.

⑤ **Mains power input** The built-in universal PSU accepts voltages from 100 to 240V AC 50/60Hz. A module with IEC inlet is fitted by default. An optional module is provided for permanent installation, with knockout holes to accept a cable gland.

⚠ Replacement of the IEC AC inlet module and mains wiring for permanent installation must be performed by a qualified electrician. See instructions later in this guide.

Front panel

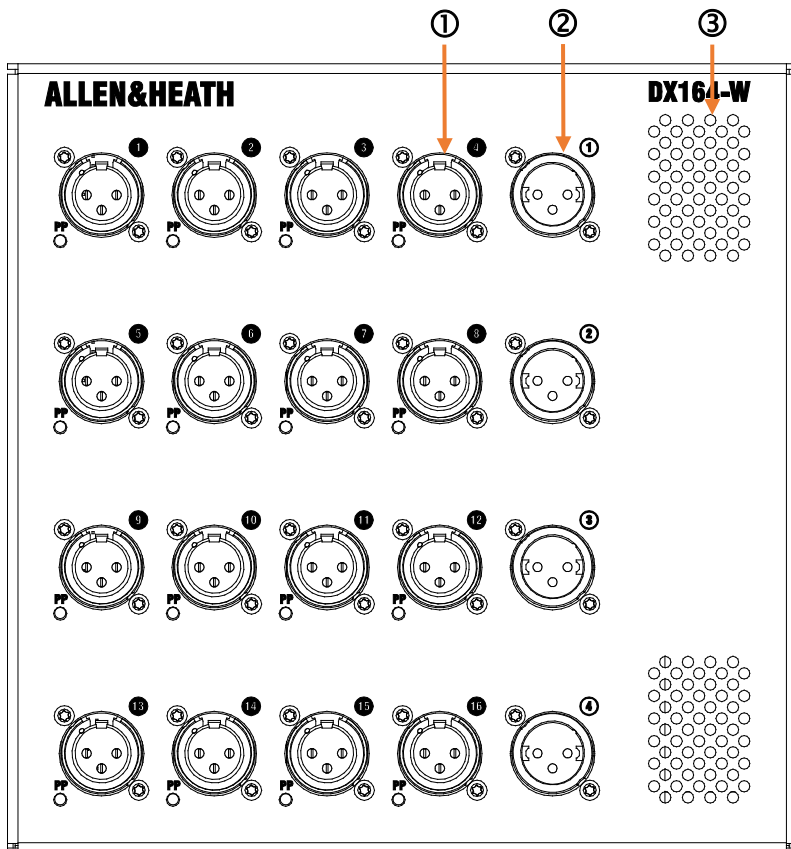

① **Input sockets** Balanced XLR mic/line inputs with +48V Phantom Power indicator. The preamps are built into the DX164-W and their Gain, Pad and +48V are controlled from the mixer via the DX link.

The +48V indicator detects voltage at the socket whether supplied by the DX164-W or received from an external source.

② **Output sockets** Balanced XLR outputs operating at nominal +4dBu level.

③ **Vents** Ensure good ventilation at the front of the unit. Avoid obstruction of vents while operating. Avoid dirt or liquid ingress.

Installation – mounting

WARNING

To prevent injury, this apparatus must be securely attached to the floor/wall in accordance with the installation instructions.

Mounting on a wall Use the mounting frame AH11504 in the orientation shown below. Fix the frame to the wall using appropriate fixings or screws for the type of wall, then align the threaded inserts on the sides of the DX164-W with the frame, and secure the unit in place with the 6x M4 6mm T20 screws provided.

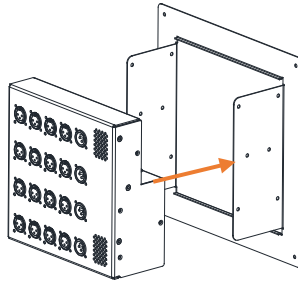

Flush mounting in a wall Use the mounting frame AH11504 in the orientation shown below. Align the threaded inserts on the sides of the DX164-W with the frame, and secure the unit in place with the 6x M4 6mm T20 screws provided. Connect the power and Cat5 cable/s, then fix the assembly to the wall using appropriate fixings or screws for the type of wall.

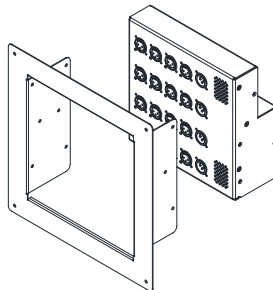

Floor mounting The DX164-W can be mounted in a floor box / stage pocket / dip trap. It must be installed in accordance with local installation and wiring regulations. We recommend using the **ACE Backstage 174SLBK** stage pocket system for use with the DX164-W.

Other options The DX164-W will fit a 12x12" NEMA Type 1 / IP10 box or equivalent. A custom mounting frame might be required.

Permanent installation with the gland module

⚠ Replacement of the IEC AC inlet module and mains wiring for permanent installation must be performed by a qualified electrician and carried out in accordance with local wiring regulations.

To replace the IEC module:

- Remove the 4 screws using a Torx T8 driver.
- Pull out the module and unplug the harness at the bottom of the assembly.
- Fit a suitable cable gland or grommet appropriate to the cable wire size to the gland module plate.
- Run the mains cable through the gland. Minimum cable size 0.75mm² or 20 AWG.
- Wire the mains cable to the terminal connector on the gland module, paying attention to polarity and earth grounding as indicated on the module.
- Securely tighten the cable gland around the cable.
- Re-plug the internal harness into the bottom of the gland module.
- Secure the module to the unit with the 4x T8 screws.

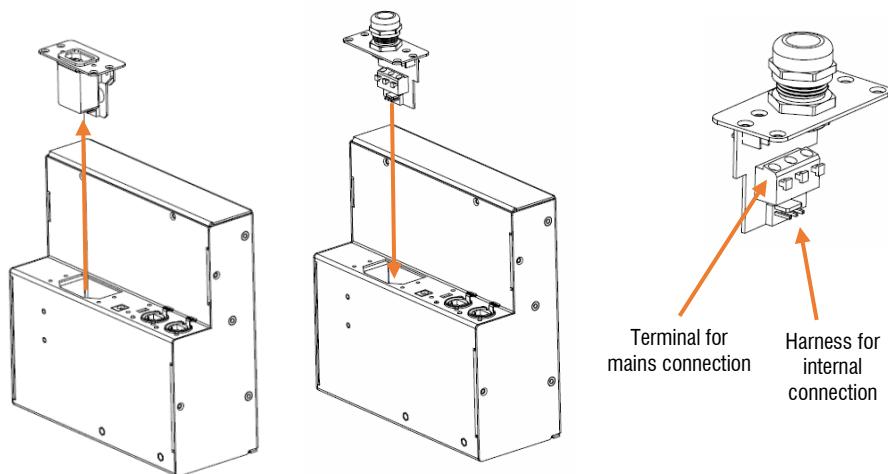

⚠ POWER DISCONNECTION

The mains supply disconnect device is the installation all pole circuit breaker or the switched fused outlet which must be labelled and must be accessible so as to be readily operable when the appliance is in use.

Dimensions

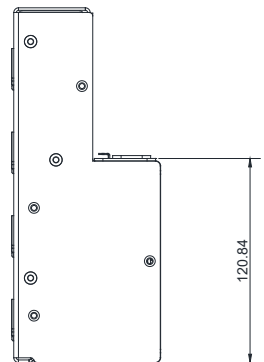
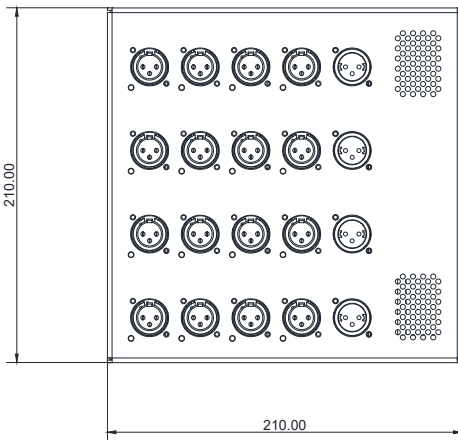
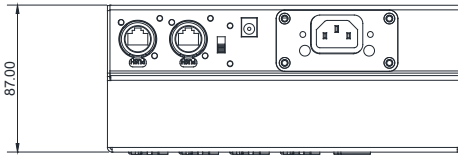

Specification

Mic/Line XLR Inputs	Balanced XLR, +48V phantom power
Mic/Line Preamp	Fully recallable
Input Sensitivity	-60 to +15dBu
Analogue Gain	+5 to +60dB, 1dB steps
Pad	-20dB Active PAD
Maximum Input Level	+30dBu (PAD in)
Input Impedance	>4k Ω (Pad out), >10k Ω (Pad in)
Mic EIN	-127dB with 150 Ω source

Analogue XLR Outputs	Balanced, Relay protected
Output Impedance	<75 Ω
Nominal Output	+4dBu = 0dB meter reading
Maximum Output Level	+22dBu
Residual Output Noise	-92dBu (muted, 20-20kHz) -90dBu (muted, 20-40kHz)

Operating Temperature Range 0°C to 40°C (32°F to 104°F)

Power

Mains Voltage Operating Range	100-240V AC, 50/60Hz
Mains Power Consumption	35W max
DC Input	12V DC, 3A max

Dimensions and Weight

	<i>Width x Depth x Height x Weight</i>
DX164-W	210 x 87 x 210 mm x 3.2kg (8.25" x 3.5" x 8.25" x 7lbs)

Read the Safety Instructions Sheet included with the product and the information printed on the panel before operating.

California Proposition 65 warning: This product may contain a chemical known to the State of California to cause cancer, or other birth defects or other reproductive harm. For more information see www.allen-heath.com/legal

A limited one year manufacturer's warranty applies to this product, the conditions of which can be found at: www.allen-heath.com/legal

By using this Allen & Heath product and the software within it you agree to be bound by the terms of the relevant End User Licence Agreement (EULA), a copy of which can be found at: www.allen-heath.com/legal

Register your product with Allen & Heath online at: <http://www.allen-heath.com/support/register-product/>

Check the Allen & Heath website for the latest documentation and software updates

ALLEN&HEATH

Copyright © 2018 Allen & Heath. All rights reserved