

Electronic Keyboard

Owner's Manual

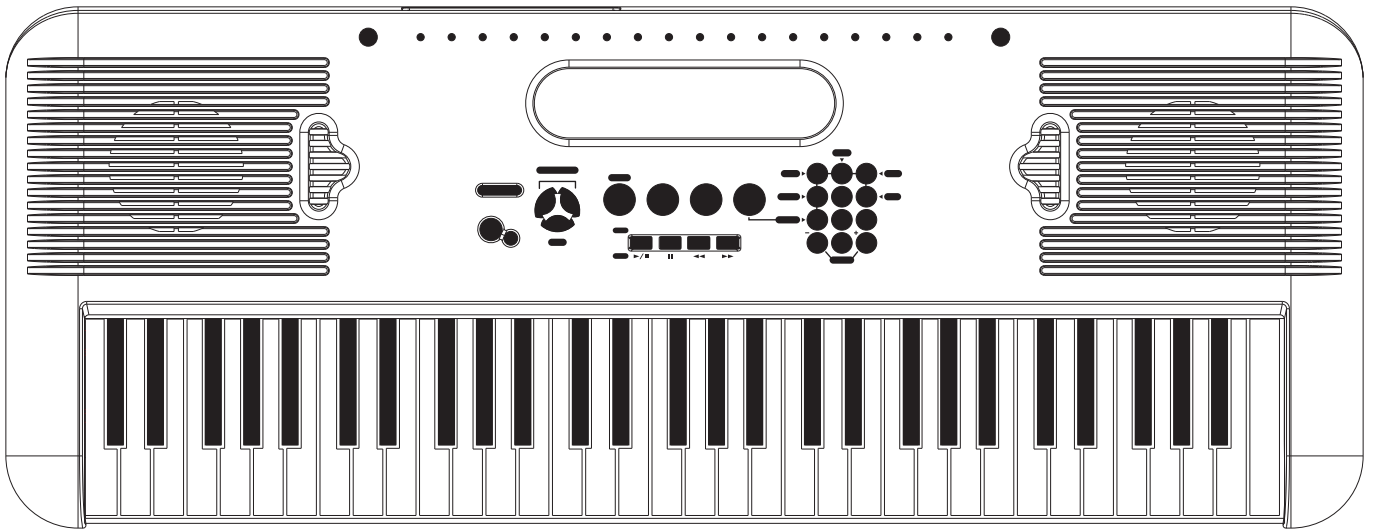

INFORMATION FOR YOUR SAFETY

THE FCC REGULATION WARNING (for USA)

This equipment has been tested and found to comply with the limits for a Class B digital device, pursuant to Part 15 of the FCC Rules.

These limits are designed to provide reasonable protection against harmful interference in a residential installation. This equipment generates, uses, and can radiate radio frequency energy and, if not installed and used in accordance with the instructions, may cause harmful interference to radio communications. However, there is no guarantee that interference will not occur in a particular installation.

If this equipment does cause harmful interference to radio or television reception, which can be determined by turning the equipment off and on, the user is encouraged to try to correct the interference by one or more of the following measures:

- Reorient or relocate the receiving antenna.
- Increase the separation between the equipment and receiver.
- Connect the equipment into an outlet on a circuit different from that to which the receiver is connected.
- Consult the dealer or an experienced radio/TV technician for help.

Unauthorized changes or modification to this system can void the user's authority to operate this equipment.

Caution!

- The normal function of the product may be by Strong Electro Magnetic Interference. If so, simply reset the product to resume normal operation by following the instruction manual. In case the function could not resume, please use the product in other location.

PRECAUTIONS

PLEASE READ CAREFULLY BEFORE PROCEEDING

Please keep this manual in a safe place for future reference.

Power Supply

Please connect the designated AC adaptor to an AC outlet of the correct voltage.

Do not connect it to an AC outlet of voltage other than that for which your instrument is intended.

Unplug the AC power adaptor when not using the instrument, or during electrical storms.

Connections

Before connecting the instrument to other devices, turn off the power to all units. This will help prevent malfunction and / or damage to other devices.

Location

Do not expose the instrument to the following conditions to avoid deformation, discoloration, or more serious damage:

- Direct sunlight
- Extreme temperature or humidity
- Excessive dusty or dirty location
- Strong vibrations or shocks
- Close to magnetic fields

Interference with other electrical devices

Radios and televisions placed nearby may experience reception interference. Operate this unit at a suitable distance from radios and televisions.

Cleaning

Clean only with a soft, dry cloth.

Do not use paint thinners, solvents, cleaning fluids, or chemical-impregnated wiping cloths.

Handling

Do not apply excessive force to the switches or controls.

Do not let paper, metallic, or other objects into the instrument. If this happens, unplug the AC adaptor from the wall outlet. Then have the instrument inspected by qualified service personnel.

Disconnect all cables before moving the instrument.

Contents

Panel & Display Description

Front Panel.....	4
Rear Panel.....	4
LCD Display.....	4

Preparation

Power Supply.....	5
Setting the Music Stand.....	5

Connections

Headphones Jack.....	6
Sustain Jack.....	6
USB Jack.....	6

Basic Operation

Power Switch.....	7
Master Volume.....	7

Voices and Effects

Select a Voice.....	8
Dual Voice.....	8
Lower Voice/Split Point.....	9
Sustain.....	9
DSP Effect.....	9

Style Control

Select a Style.....	10
The Accompaniment Section.....	10
Start a Style.....	11
Stop a Style.....	12
Main/Fill.....	12
Tempo.....	12
Chord Recognize.....	13
Metronome.....	15
One Touch Setting.....	15
Accomp Volume.....	15

Record

Start Recording.....	16
Stop Recording.....	16

Play Back the Recording.....	16
------------------------------	----

Song

Lesson Mode.....	17
Lesson 1.....	18
Lesson 2.....	18
Lesson 3.....	19
Grade Function.....	19

Demo

Enter Demo.....	20
Exit Demo.....	20

Function Menu

Transpose.....	21
Octave.....	21
Beat.....	21
Split Point.....	21
MIDI IN.....	22
MIDI OUT.....	22
Touch.....	22
Tune.....	22
Reverb Level.....	22
Chorus Level.....	23
Pedal Assign.....	23

Chord Dictionary.....	24
------------------------------	-----------

MIDI Function

What is MIDI.....	25
USB Connection.....	25
MIDI Application.....	25

Appendices

Specifications.....	26
Appendix 1- Voice List.....	27
Appendix 2 - Style List.....	29
Appendix 3 - Demo List.....	29
Appendix 4 - Song List.....	30
Appendix 5 - Chord List.....	30
Appendix 6 - MIDI List.....	31

Panel & Display Description

Front Panel

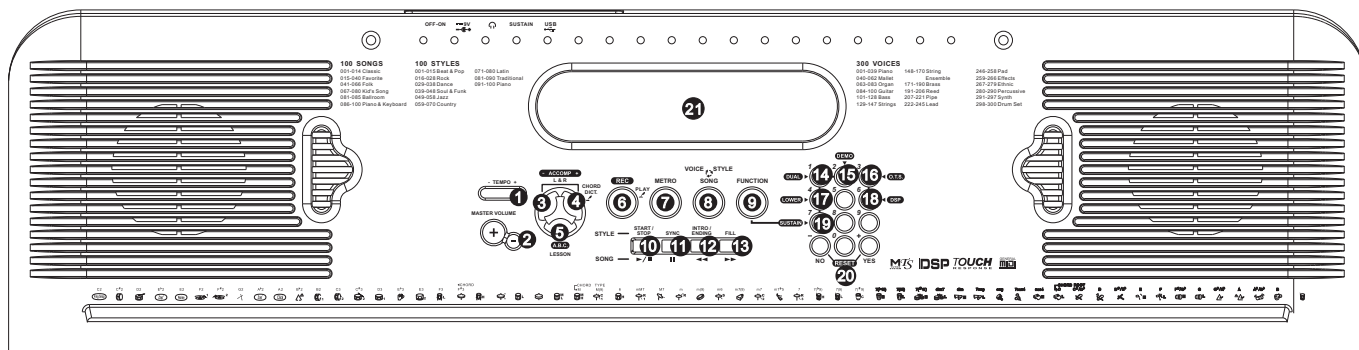

- 1 TEMPO +/-
- 2 MASTER VOLUME
- 3 LEFT HAND LESSON MODE
- 4 RIGHT HAND LESSON MODE / CHORD DICTIONARY
- 5 AUTO BASS CHORD/LESSON
- 6 RECORD
- 7 METRO
- 8 VOICE/STYLE/SONG
- 9 FUNCTION
- In Style Mode**
- 10 START/STOP
- 11 SYNC
- 12 INTRO / ENDING
- 13 MAIN / FILL
- In Song Mode**
- 10 START/STOP ▶/■
- 11 PAUSE "
- 12 REW ◀◀
- 13 FF ▶▶
- 14 DUAL
- 15 DEMO
- 16 ONE TOUCH SETTING
- 17 LOWER
- 18 DSP
- 19 SUSTAIN
- 20 NUMERIC KEYPAD
- 21 LCD DISPLAY

Rear Panel

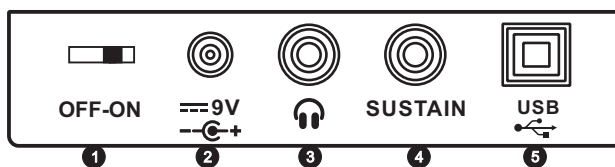

- 1 POWER ON/OFF
- 2 POWER JACK
- 3 PHONES JACK
- 4 SUSTAIN JACK
- 5 USB JACK

LCD Display

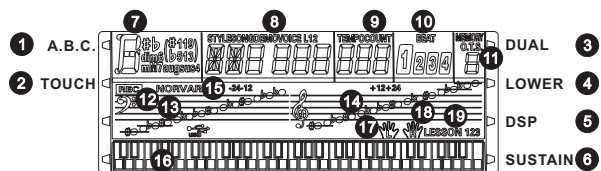

- 1 A.B.C.
- 2 TOUCH
- 3 DUAL
- 4 LOWER
- 5 DSP
- 6 SUSTAIN
- 7 CHORD
- 8 VOICE/STYLE/DEMO /SONG
- 9 TEMPO/COUNT
- 10 BEAT
- 11 ONE TOUCH SETTING
- 12 RECORD
- 13 BASS CLEF
- 14 TREBLE CLEF
- 15 NOR / VAR
- 16 61-KEY KEYBOARD
- 17 LEFT
- 18 RIGHT
- 19 LESSON 1 / 2 / 3

Preparation

Power Supply

This electronic keyboard can be powered by the current of a standard household wall outlet (using the specified AC adaptor) or by batteries.

1. Using the AC Adaptor

Make sure that only the AC adaptor specified for this electronic keyboard is used. The adaptor shall be 9V DC output, center positive type. Be sure to turn off the electronic keyboard before you connect the adaptor into the AC wall outlet and the cord into the unit.

2. Using Batteries

Always make sure to turn the keyboard off before inserting new batteries or replacing old ones.

● To insert batteries

Open the battery compartment on the bottom of the keyboard.

Insert 6 "AA"-size (SUM-3, LR6) batteries into the battery compartment and follow the correct polarity.

Replace the compartment cover and make sure that it locks firmly in place.

● Low battery indications

Any of the following symptoms indicate low battery power. Replace the batteries as soon as possible if any of the following occurs.

A dim and difficult-to-read LCD display.

Abnormally low speaker/headphone volume.

Distortion of the sound output.

Sudden power failure when playing at high volume.

Abnormal rhythms or demo songs are played.

Dimming of the display when playing at high volume.

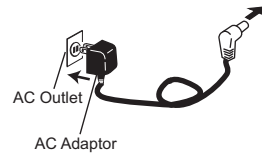

CAUTIONS!

- Use only the specified AC adaptor. Using other types of adaptor creates the risk of and electrical shock.
- For safety sake, be sure to unplug the AC adaptor from the wall outlet whenever leaving the electronic Keyboard unattended for a long time.

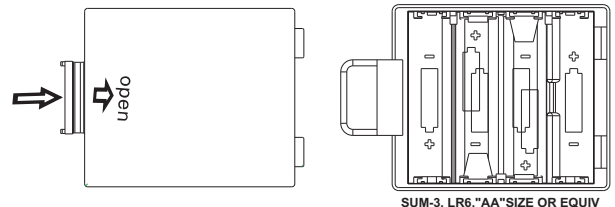

SUM-3, LR6, "AA" SIZE OR EQUIV

CAUTIONS!

- When inserting batteries, make sure to follow the polarity marking.
- Never use batteries of different types.
- Never mix old batteries with new ones.
- Replace the batteries as soon as possible after any sign of discharge.
- Always remove the batteries from the battery compartment when the keyboard is not expected to be used for a long period of time.

Setting Music Stand

Please set up the music stand as the instruction below:

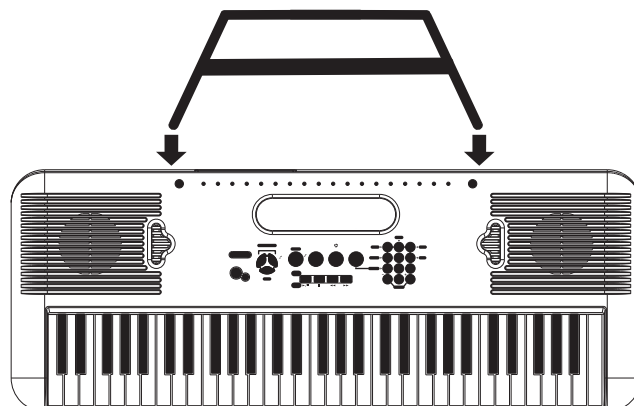

Connections

Headphones Jack

1. If you prefer to play with headphones for high quality personal monitoring, plug a set of stereo headphones into the rear panel PHONES jack.
2. Plug a set of headphones into the PHONES jack and the speakers will be disabled automatically.

NOTE:

Never use headphones in high volume, as it may hurt your ears.

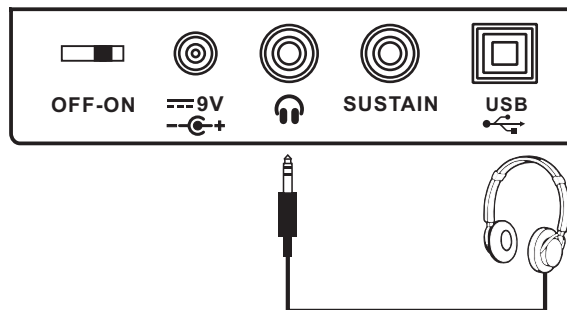

Sustain Jack

1. An optional footswitch can be plugged into the SUSTAIN jack for sustain control.
2. The footswitch functions like the damper pedal of a piano. Step on the footswitch, all notes played on the keyboard have a longer sustain effect, release for normal sound.

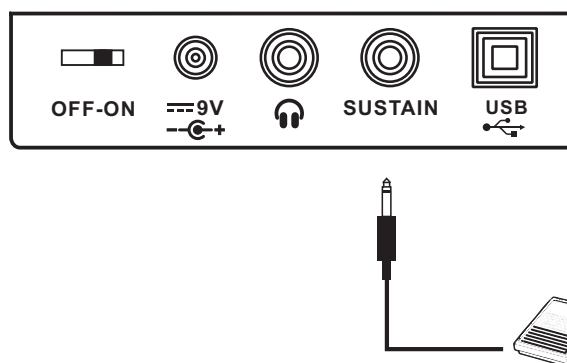

USB Jack

1. Connect PC or other USB host devices that support USB Audio.
2. For devices with USB cable, after the driver is installed and initialization is finished, you can choose USB Audio Device in the device menu of the software to transfer midi data.

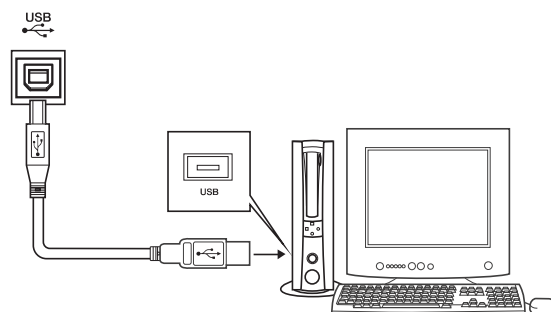

⚠ WARNING

To avoid damages, turn the power switches of this keyboard and all related devices OFF if you want to plug in or unplug between this instrument with all related devices.

Basic Operation

Power Switch

1. First, please ensure the correct connection has been made based on the previous instruction.
2. Turn the [POWER] switch on. The LCD display lights up.

NOTE:

If the LCD display does not light up after you turned on the keyboard, please check the power supply.

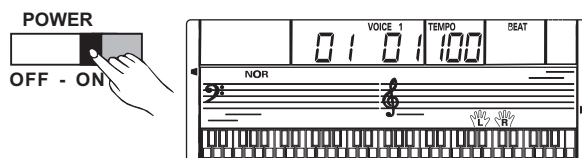

Master Volume

1. The keyboard volume could be adjusted from 0 to 31 by pressing [MASTER VOLUME +] and [MASTER VOLUME -] button LCD will display MVL XX.
2. Press [MASTER VOLUME +] and [MASTER VOLUME -] buttons simultaneously to set to the default value MVL 23.

NOTE:

If the keyboard is in silent, that means the volume may has been adjusted to its minimum level or the headphones jack has been connected.

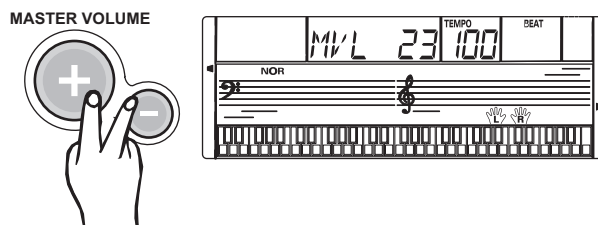
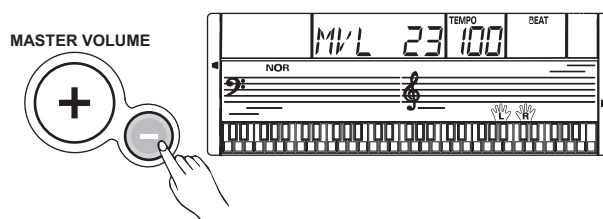

Voices and Effects

There are 300 voices in total (See appendix).

Select a Voice

1. The default VOICE is “NO.01 Acoustic Grand piano”. LCD displays “VOICE 1” and the voice number.
2. The [+ / YES] and [- / NO] buttons:
Press [+ / YES] or [- / NO] button to select the voice you want.
The selected voice number will be shown on the display.
The number buttons:
The number buttons can be pressed directly to select your desired voice.
3. After selecting a voice, you can now play the keyboard.

NOTE:

- Use [STYLE / SONG / VOICE] button to switch mode (Voice Mode, Style Mode and Song Mode).
- When repeatedly press [STYLE / SONG / VOICE] button, will quit “Song Mode” and enter “Voice Mode” or from “Voice Mode” switch to “Style Mode”.
- While playing song, you can not switch mode.

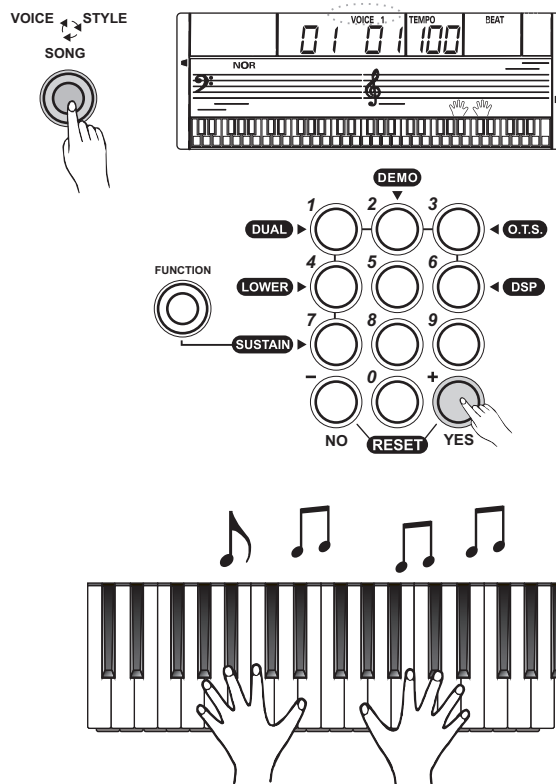

Dual Voice

You can play two sounds at the same time on the keyboard. It is called “Dual Voice mode”. When the dual function is off, the voice indicator is VOICE 1. When the dual function is on, the voice indicator is VOICE 2.

The dual voice function is set to OFF when keyboard power on.

1. During the VOICE 1 status, you could press and hold down [FUNCTION] button at first, and then press [1] button to enter the dual voice mode.
“VOICE 2” and “DUAL” icon would be lightened simultaneously. The number of the dual voice will be displayed on the LCD. Now, you can get two different sounds at the same time when pressing one key.
2. Press [+ / YES] / [- / NO] button or number buttons to select you desired voice.
The default DUAL VOICE number is NO.154 Synth Strings 3.
3. Press and hold down [FUNCTION] button at first, and then press [1] button to turn off the DUAL VOICE.
The note you play sounds a single voice of Voice 1.

NOTE:

While the keyboard is splitted, only the right hand can respond the dual voice, the left hand area can't.

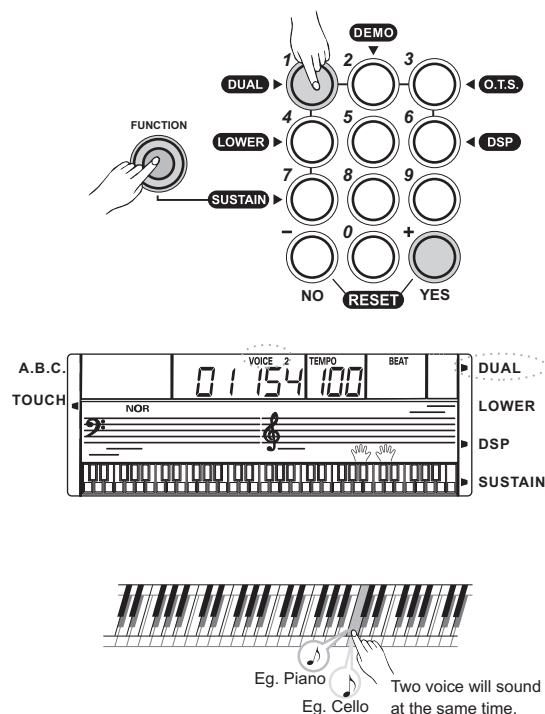

Lower Voice / Split Point

You can play two sounds on different parts of the keyboard. It is called “Split Mode”.

The lower voice function is set to OFF when keyboard power on.

1. Press and hold down [FUNCTION] button at first, then press [4] button to turn on the LOWER VOICE, LCD lights the “LOWER” flag and displays “VOICE L” and its number.
2. Press [+ \YES] / [- \NO] button or number button to select the voice you want. The default lower voice number is “No.154 Synth Strings 3”.
3. Press and hold down [FUNCTION] button at first, then press [4] button to turn off the LOWER VOICE. LCD darkens its flag.

NOTE:

The default split key is F#3(19), Turn to “Function Menu” page for more detail.

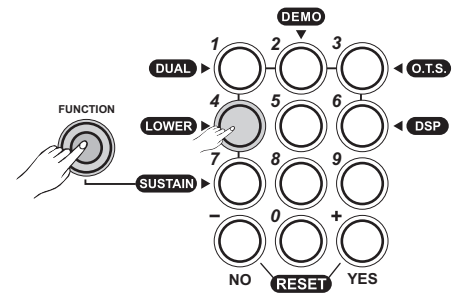

Sustain

This function helps you to get a voice with a sustained effect, while playing the keyboard. The sustain effect is set to OFF when keyboard power on.

1. Press and hold down [FUNCTION] button at first, then press [7] button to activate the sustain effect. The “SUSTAIN” flag lightens on the display.
2. Press and hold down [FUNCTION] button at first, then press [7] button to eliminate the sustain effect. The “SUSTAIN” flag will disappear.

NOTE:

When you step on the sustain pedal, the sustain effect will be stronger than the effect by pressing [SUSTAIN] button.

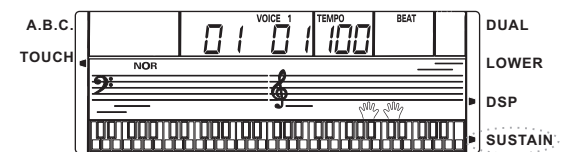
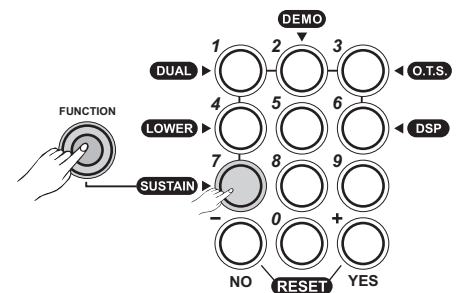

Dsp Effect

This function allows you to perform the overall sound in a realistic style.

The DSP Effect is set to ON when keyboard power on.

1. Press and hold down [FUNCTION] button at first, then press [6] button to turn on DSP effect. The “DSP” flag lightens on the display.
2. Press and hold down [FUNCTION] button at first, then press [6] button to turn off the DSP effect. The “DSP” flag will disappear.

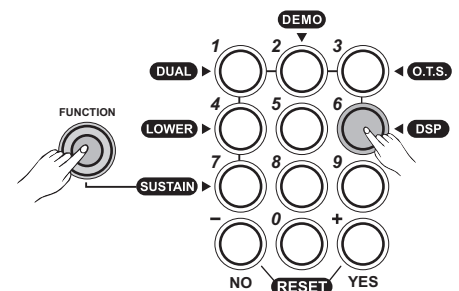

Style Control

The keyboard has a total of 100 styles, from 01 to 100, including 10 piano styles.

Select a Style

1. Press the [STYLE/SONG/VOICE] button to set the keyboard to the "Style Mode". The default STYLE 1 is NO:01; LCD will display the STYLE flag and its number.
2. **[+ / YES] and [- / NO] buttons:**
Press [+ / YES] or [- / NO] to choose your desired style. The selected style number will be shown on the display.
The number buttons:
The number buttons can be pressed directly for selecting the number of your desired style.
3. After selecting a style, you can start playing the keyboard.
4. When a style is playing, you can select a new style at any time. The number of the new style will be displayed on the LCD immediately. If the style changes at beat one, the new style will be played at once; if the style changes at other beats, the new style will start in the next measure. The new style will be playing with the old tempo.

NOTE:

The style, song and voice use composite button [STYLE / SONG / VOICE]. You could press the button continuously to quit "Voice Mode" and enter "Style Mode", or switch "Style Mode" to "Song Mode".

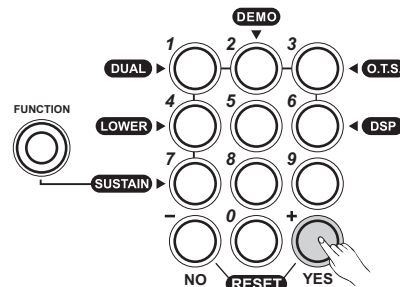
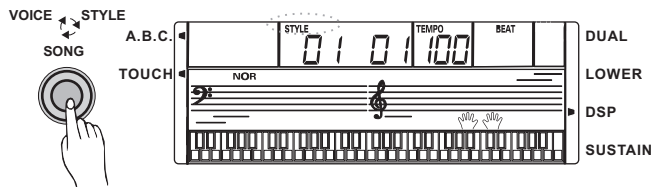

The Accompaniment Section

Accompaniment consists of Intro, Main, Fill and Ending. Using different sections based on the different structures of styles enable you to enhance the overall musical performance.

INTRO

Press the [INTRO/ENDING] button to insert an intro section before you start to play. The rhythm will begin with a 2-4 measure introduction which will be followed by a menu section.

FILL and MAIN

While the accompaniment is playing, you can fill in the rhythm/accompaniment by pressing the [FILL] button. This will automatically insert a fill section. After fill section over, Accompaniment will automatically return to the MAIN style. Each main section consists of 1 to 4 measures.

ENDING

When you press the [INTRO/ENDING] button, it brings ending section appropriate for the accompaniment, and then stop the performance.

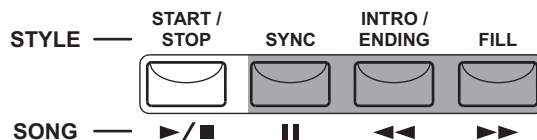

Start a Style

1. Start immediately:

Press [START/STOP] button to start the style, the drum beats of the style will be played at once. The beats will be shown on the LCD alternately.

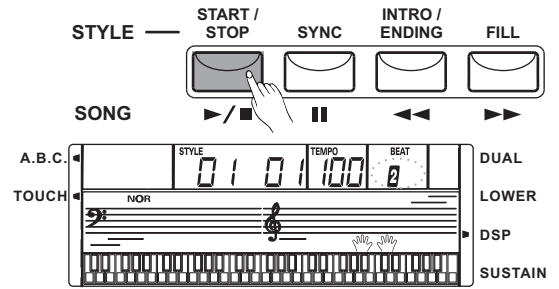

2. "A.B.C." mode

The default setting of A.B.C. is off.

Press [A.B.C./LESSON] button to turn on the auto bass chord. The area to the left of split point is known as the chord area.

When playing the chord, both the bass and the chord voice sound.

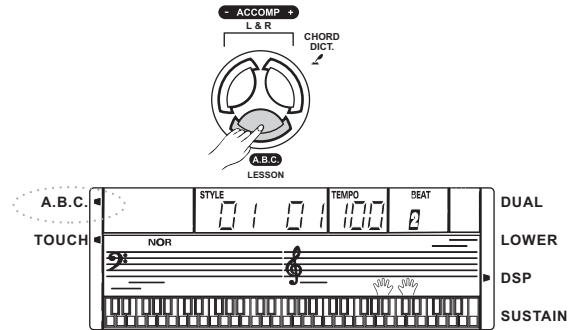

3. Sync Start

Press [SYNC] button to enter the sync start waiting mode. The 4 beats on the LCD flash together.

If the A.B.C. mode is on, play any key in chord area, the style start playing with bass and chord.

If the A.B.C. mode is off, play any key on keyboard, the style playing only the drum voice.

Press [SYNC] button again to stop the style.

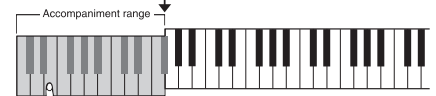
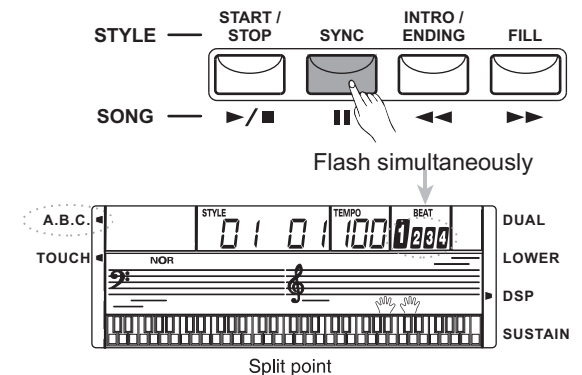

4. Intro Start:

Press [INTRO/ENDING] button when the style is not playing, NOR flag will flash on the LCD, indicating the intro section is ready to play.

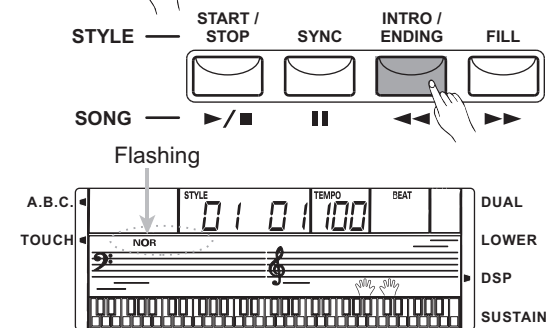

Press [START/STOP] button, then the style starts with an intro section, followed by the main section.

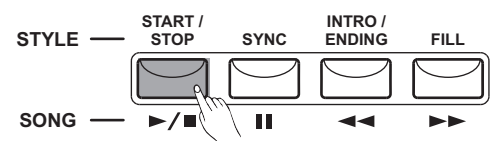

Style Control

Stop a Style

1. Stop immediately

The accompaniment can be stopped at any time by pressing [START/STOP] button.

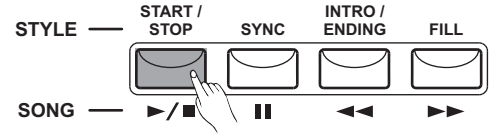

2. Ending stop

Press [INTRO/ENDING] button to complete style with an ending section.

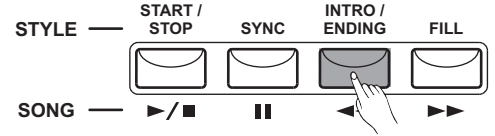

3. Sync stop

Press [SYNC] button to stop playing style, the synchronized start mode will be activated.

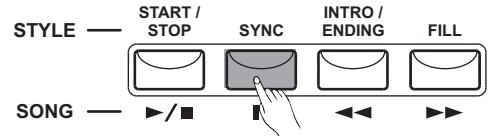

Main/Fill

1. In MAIN mode, press [FILL] button to insert 1 measure fill section and LCD flashes "NOR"; after one measure is over, MAIN style will be returned.

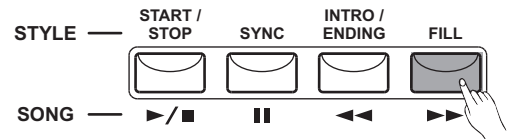

2. Press and hold down [FILL] button when style is playing, the selected FILL pattern repeats continuously until the button is released.

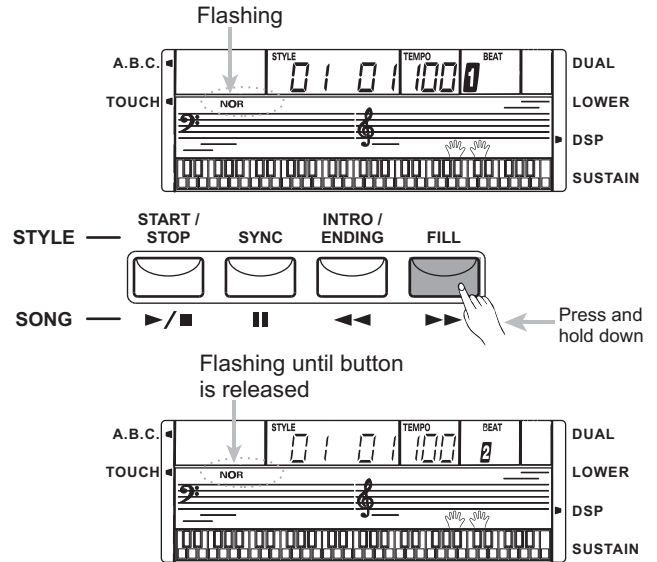

Tempo

1. Press [TEMPO +] or [TEMPO -] button to change the tempo: 30 - 280

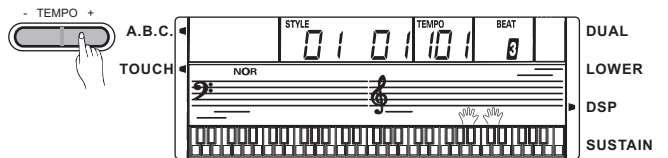

2. Press [TEMPO +] and [TEMPO -] button simultaneously to set the tempo value back to its default.

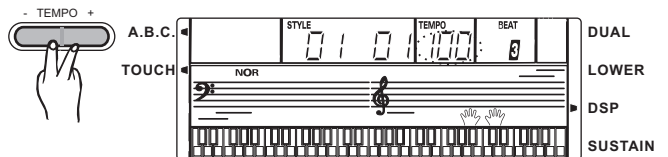

Note:

When the style stops while selecting style, the tempo will change with the style automatically to the default tempo. When style is playing, the tempo will not change with the style.

Chord Recognize

“A.B.C.” is disabled during the default setting. Press [A.B.C.] button to turn on this “auto bass chord” function; the A.B.C. flag on the LCD is lightened. The left section of the keyboard is known as the “chord area”, while playing the chord, both the bass and the chord voices phonate.

Press [A.B.C.] button again to turn off “auto bass chord” function. The “A.B.C.” flag will disappear

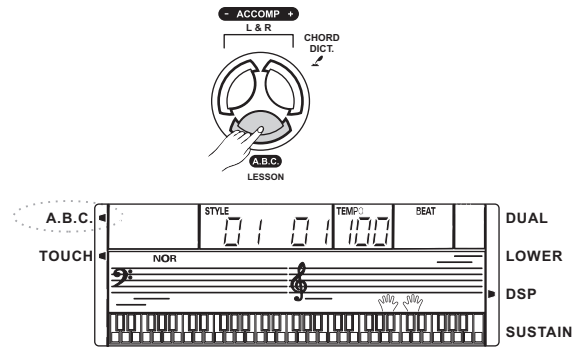

There are 2 ways to detect a chord: “single finger detect” and “multi fingers detect”.

If the chord played is based on "multi fingers detect", it is recognized as the “multi fingers chord”.

If not, “single finger chord” will be recognized.

Chord Basics

A chord, in music, is any harmonic set of three or more notes that is heard as if sounding simultaneously. The most frequently encountered chords are triads. A triad is a set of three notes that can be stacked in thirds. When stacked in thirds, the triad's members, from lowest pitched tone to highest, are called: the Root, the Third, and the Fifth.

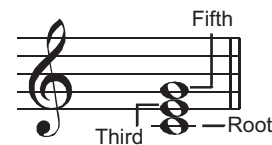

Triad Type

There are following basic triad types:

Major Triad	A root with a major third added above and a perfect fifth will consist as a Major Triad.
Minor Triad	A root with a minor third added above and a perfect fifth will consist as a Minor Triad.
Augmented Triad	A root with a major third added above and an augmented fifth will consist as an Augmented Triad.
Diminished Triad	A root with a minor third added above and a diminished fifth will consist as a Diminished Triad.

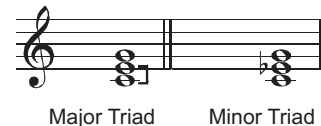

Major Triad Minor Triad

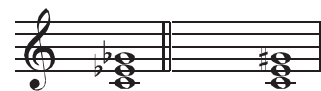

Augmented Triad Diminished Triad

Chord Inversion

We define this chord its root is not in the bass (i.e., is not the lowest note) as an inversion chord. When the root is in the bass, we call the chord: root-position chord. If we put the Third and Fifth in the root position, then it forms Inversion, we call this chord Inversion Chord. See the following major triad and its inverted chord.



Root Position First Inversion Second Inversion

Chord Name

The chord name contains two parts content: Chord root and Chord type.

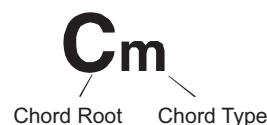

Single Finger

Single finger type not only can detect single finger but also can detect multi finger. And the single finger makes it easily to play chords through only one, two or three keys. Including major, minor, seventh, and minor seventh chord. Refer to relevant picture on the right for details.

C		★ Major Triad Only press the root note on the keyboard.
Cm		★ Minor Triad Press the root note and the nearest left black key simultaneously.
C7		★ Seventh chord Press the root note and the nearest left white key simultaneously.
Cm7		★ Minor seventh chord Press the root note and the nearest left white and black keys simultaneously.

Multi Finger

Multi finger type only can recognize those chords have listed in the chord list, and also can be found in the dictionary function.

Note:

In full range mode, the entire keyboard will only recognize chords played in normal fingering.

0 C	1 C ₆	2 CM ₇	3 CM ₇ (#11)	4 CM(9)	5 CM ₇ (⁹)
6 C ₆ (⁹)	7 Caug	8 Cm	9 Cm ₆	10 Cm ₇	11 Cm ₇ (b5)
12 Cm(9)	13 Cm ₇ (⁹)	14 Cm ₇ (¹¹)	15 CmM ₇	16 CmM ₇ (⁹)	17 Cdim
18 Cdim ₇	19 C ₇	20 C ₇ sus ₄	21 C ₇ (b5)	22 C ₇ (⁹)	23 C ₇ (#11)
24 C ₇ (¹³)	25 C ₇ (b9)	26 C ₇ (b13)	27 C ₇ (#9)	28 CM ₇ aug	29 C ₇ aug
30 Csus ₄	31 C1+2+5	Notes enclosed in parentheses are optional; the chords could be recognized without them.			

One Touch Setting

When One Touch Setting is switched on, you can instantly recall all auto accompaniment related settings including voices selection and digital effects simply with a single touch of a button.

In this function, 1 types of parameters will be loaded for operating the current style.

1. Press and hold down [FUNCTION] button at first, and then press [3] button to turn on the "O.T.S." function.

The O.T.S. flag on the LCD will be lightened.

While O.T.S. is on, the relative type of the parameter will be loaded according to the current style, and the keyboard will turn the A.B.C. mode on automatically.

2. Press and hold down [FUNCTION] button at first, and then press [3] button to turn off the O.T.S. function. LCD darkens its flag.

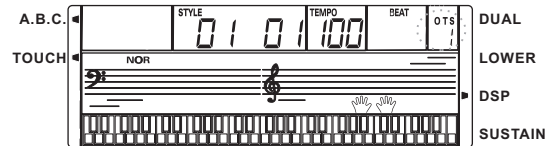
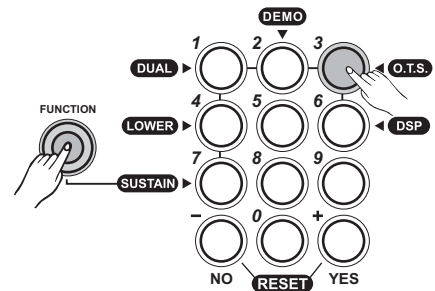

Metronome

1. Press [METRO] button to turn on the metronome.
2. Press [METRO] button again to turn off the metronome.
3. Metronome could not be played in SONG mode.

NOTE:

Metronome can be played along with the tempo as accompaniment whenever you turn on a style. Metronome could be played in Recording Mode, but it would not be recorded.

METRO

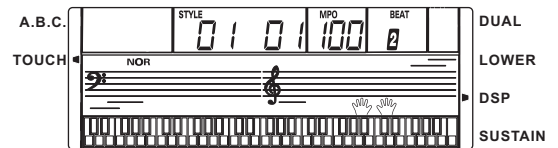

Accomp Volume

1. Press [ACCOMP +] or [ACCOMP -] button to adjust volume of accompaniment in style playing. The LCD displays the accomp volume which range between 0 and 31. Default Accomp Volume is 28.

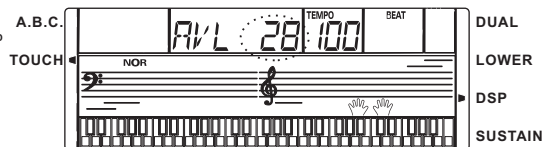
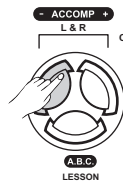

2. Press [ACCOMP +] and [ACCOMP -] button together to mute the ACCOMP track.

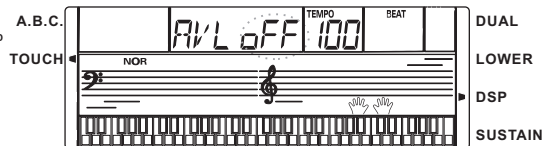

3. Press [ACCOMP +] and [ACCOMP -] button together again to turn on the ACCOMP volume.

NOTE:

When in "Song Mode" or recording playback status, the Accomp Volume function will be invalid.

Record

Start Recording

1. Press the [RECORD] button, the four-beat indicator on the LCD will flash simultaneously, indicating the “record waiting status”.

A voice and style can be selected in this status.

The ACCOMP track and MELODY track can be recorded together.

2. When all the settings have been done in “Record Waiting Status”, play the keyboard (the chord area when recording ACCOMP) or press [START/STOP] button; it will start recording and the beat will be displayed according to the current tempo.

NOTE:

Once the recording of one track is started, the original data in the track will be overwritten.

In “Record Status”, song mode will be invalid.

It means, you could not switch to the Song Mode by pressing [STYLE/ SONG/VOICE] button.

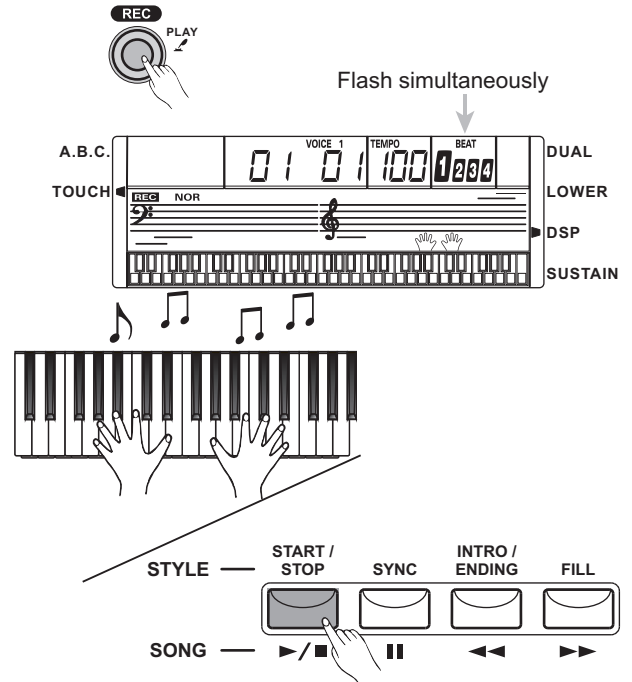

Stop Recording

1. STOP AUTOMATICALLY

While recording, once the capability is full, the recording will be stopped automatically. “FULL” will be displayed on the LCD.

2. STOP MANUALLY

Press [RECORD] button again to stop the recording immediately.

When a style is playing, press the [INTRO/ENDING] button, it will stop recording automatically after “ending”.

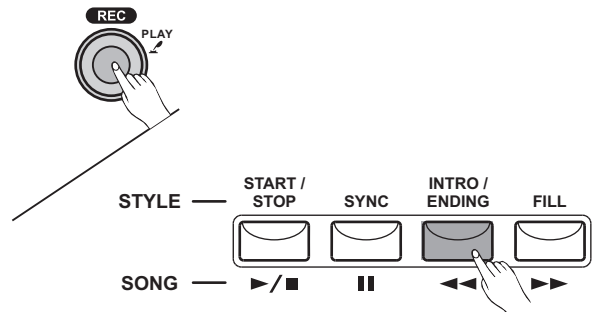

Play back the Recording

Press and hold down [REC] button 2 seconds to play back the recorded data.

Press [REC] button again (or press [START/STOP] button) could quit playback.

NOTE:

If you power off the keyboard, the recorded data would be erased.

When the capability is empty, “NULL” will be displayed on the LCD, and then quit playback state automatically.

Song

There are total 100 songs in this keyboard (see Appendix). Each song can be practised in the MELODY OFF mode.

1. START/STOP song

Press [SONG/STYLE/VOICE] button to enter the “song mode”, LCD will display “SONG” flag and its number. All songs will be played in a loop.

2. LOOP:

The second time you start playing the song by pressing [START/STOP] button, it will play the current song repeatedly.

If you want to play all songs in a loop, you should quit song mode at first, and then enter song mode again.

3. SELECT song:

Use [+ / YES] / [- / NO] button or numeric keypad to select your desired song.

4. REW, FF and PAUSE

When a song is playing, press [▶▶] button to speed forward the song.

Press [◀◀] to rewind the song (base on measure);

Press [||] to pause the song.

NOTE:

When playing song, [STYLE/ SONG/VOICE] button is invalid. If the song is in pause, the [◀◀] and [▶▶] function will be invalid. When switch from “Style Mode” to “Song Mode”, the keyboard will be waiting for 3 seconds, and then all songs will be playing in a loop.

In “waiting status”, you could press [STYLE/SONG/ VOICE] button again to switch to “Voice Mode”.

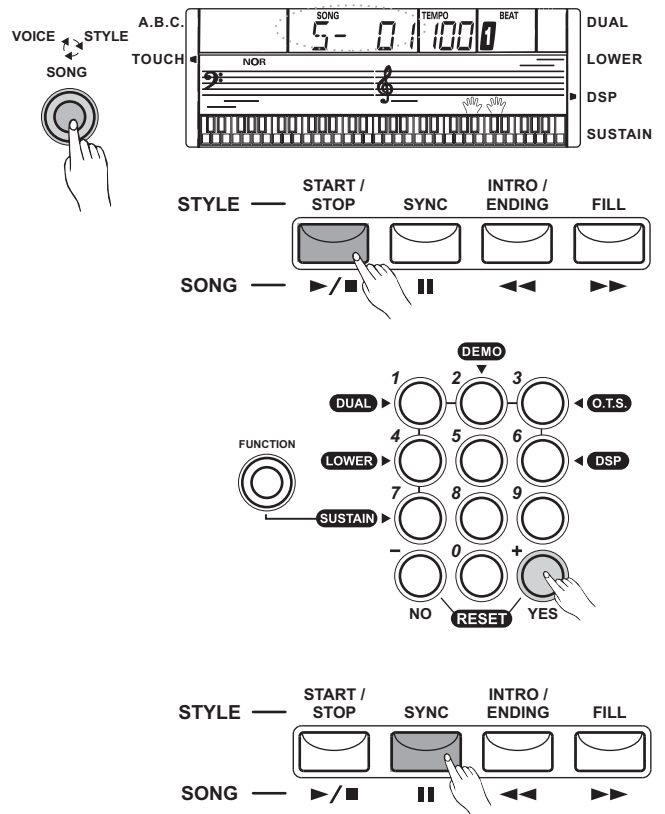

Lesson Mode

Learning a new song primarily involves with the timing of the piece and the accuracy of a note. Thus the song learning function focuses on these two elements to help you better play a song.

1. In song mode (when a song is not playing), press [A.B.C./LESSON] button to enter the Lesson mode.

2. There are 3 levels to score the performance of your playing. You can use [R] or [L] button to select which hand to practice. If neither hand is selected, the keyboard will choose the right hand automatically.

If [L] and [R] are both selected, you can use two hands to do the lesson together.

NOTE:

The contents for practising with left hand varied according to different types of songs. If you choose a chord song, the left hand practices the chord, otherwise, the left hand will be used to practise the melody.

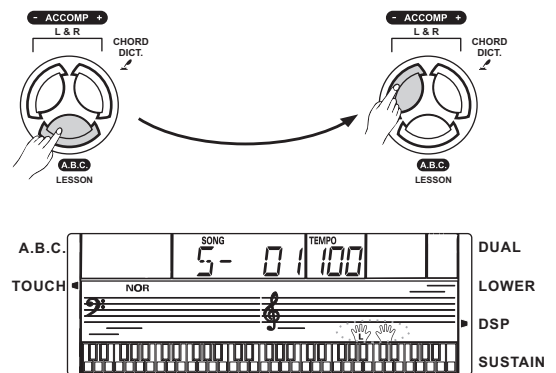

NOTE:

When a song is playing, the notes and keyboard displayed on the LCD indicate the melody and chord position, the numbered musical notation displayed on the LCD shows the last note played by the RIGHT track, and it will be convenient for you to practice .

The [R] and [L] function is invalidation in “Style Mode” and “Voice Mode”.

Lesson 1

1. Press [A.B.C./LESSON] button to enter LESSON 1, the lesson 1 flag will be lightened on the LCD.
Evaluation is based on the accuracy of the time value, and the accuracy of note playing will not be graded.
2. Press [START/STOP] to begin.
3. If [R] is selected; it will mute the melody of the right hand position and you will have to follow the timing of the right hand. As long as the timing is correct, the melody will be sounded.
4. If [L] is selected ; it will mute the changing chord / melody by the left hand. You will have to follow the timing of the left hand. As long as the timing is correct, the chord / melody will be sounded.
5. If [L] and [R] are both selected, the chord / melody on both hands will be muted. You will have to follow the timing of both the left and right hands, and the song will then play accordingly.
6. Once the lesson is completed, the result of evaluation will be announced.

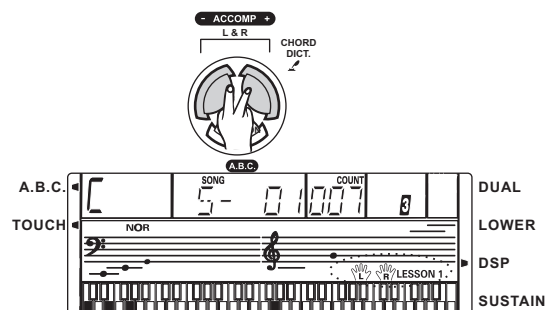
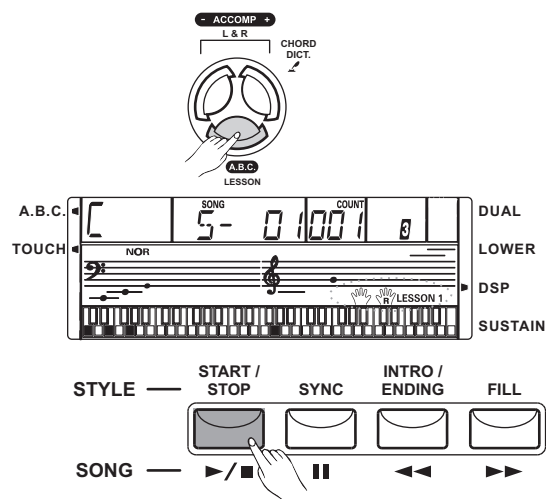

Lesson 2

1. Press [LESSON] button again to enter LESSON 2, the lesson 2 flag will be lightened on the LCD.
Evaluation is based on the accuracy of notes playing. Accuracy of time value will not be considered as the song could keep going only if the correct note is played.
2. Press [START/STOP] button to begin.
3. If [R] is selected, only the left hand will be played automatically until the first note on the right hand is played. The song will not proceed until the correct note is played.
4. If [L] is selected, only the right hand will be played. The song will not proceed until the notes of the left hand are played correctly.
5. If [L] and [R] are both selected, the song will proceed only when the notes of both hands are played correctly.
6. Once the lesson is completed, the result of evaluation will be announced.

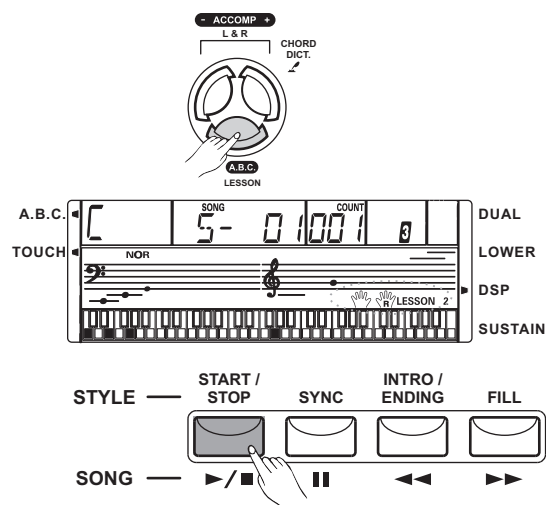

Lesson 3

1. Press [LESSON] button in LESSON 2 to enter LESSON 3 .

In this mode, you can hear what you play whether the notes are right or wrong, evaluation is based on the correctness of both the time value and notes.

2. Press [START/STOP] button to begin.
3. If [R] is selected, the melody on right hand will be muted.
4. If [L] is selected, the chord / melody on left hand will be muted.
5. If [L] and [R] are both selected, both the left and right hands will be muted, only the accompaniment will be sounded.
6. Once the lesson is completed, the result of evaluation will be announced.

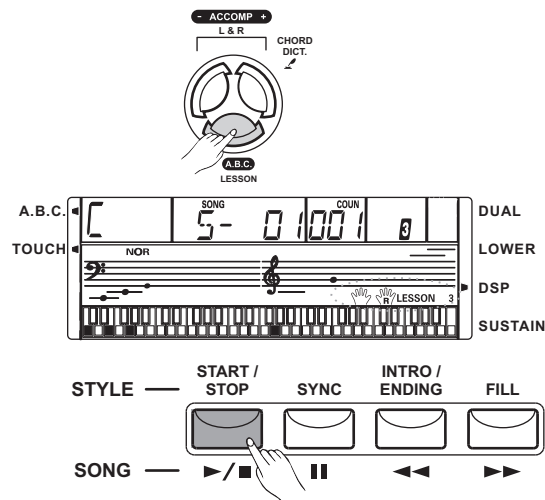

Grade Function

Lesson 1 / Lesson 2 / Lesson 3 all have the grading function. There are five levels, including: TRY AGAIN, OK, GOOD, VERY GOOD, EXCELLENT.

After a grade is given, the song will be played again and retain lesson mode.

Demo

Demo

Enter Demo Mode :

Press and hold down [FUNCTION] button at first, then press [2] button to enter the "Demo Mode", LCD will display "DEMO" flag and its number. The keyboard will be playing songs 082, 001, 063, 073, 012, 046, 004, 031, 025, 060 in a loop.

NOTE:

You can enter "Demo Mode" anytime by press the right buttons.

Exit Demo Mode :

1. In "Demo Mode", Press and hold down [FUNCTION] button at first, then press [2] button to stop playing and exit demo mode.
2. In "Demo Mode", press [START/STOP] button to stop playing and exit demo mode

NOTE:

In "Demo Mode", keyboard was invalid.

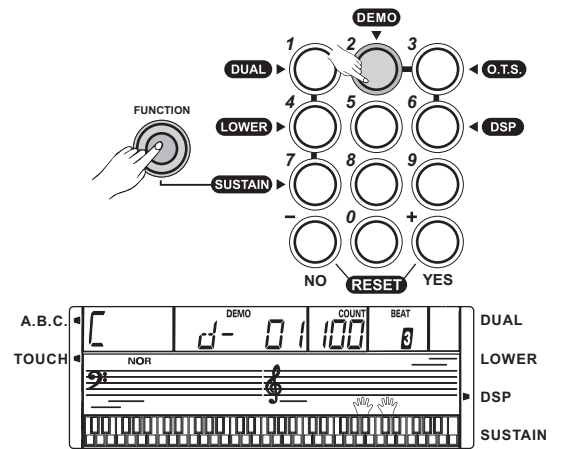

Function Menu

Press [FUNCTION] key to enter the menu of function. The default option of function menu is "TRANPOSE". Everytime you enter the menu, it will return to the option that you selected last time. Repeatedly press [FUNCTION] key to select the option you would like to set. Use the [+ / YES] / [- / NO] button to set the parameter. The option and the parameters are indicated on the right:

NOTE:

If there is no action 5 seconds after pressing the [FUNCTION] key, it will quit the function menu automatically.

Press [YES] and [- / NO] button together to set the option value back to its default.

The reverb and chorus level will change with the automatically to the default level.

Option	LCD Display	Range	Default
TRANPOSE	xPS 00	-12 ~ 0 ~ 12	0
OCTAVE	OCt 00	-1 ~ 0 ~ 1	0
BEAT	bEt 04	0, 2 ~ 9	4
SPLIT POINT	SPt 19	1 ~ 61	19
MIDI RECEIVE	CHI ALL	01 ~ 16, ALL	ALL
MIDI TRANSMIT	CHo 01	01 ~ 16	01
TOUCH	TCH 02	1,2,3,OFF	2
TUNE	TUE 00	-50 ~ 50	0
REVERB LEVEL	REL XXX	0 ~ 127	045
CHORUS LEVEL	CHL XXX	0 ~ 127	0
PEDAL ASSIGN	SUSIA n,SOFT,ST-SP	SUSTAIN,SOFT,START/STOP	SUSTAIN

Transpose

Press [FUNCTION] button to enter the TRANPOSE sub-menu. The LCD displays the current transpose value.

Use [+ / YES] / [- / NO] to adjust the transpose value from -12 to 12 semitones.

The default setting is 000.

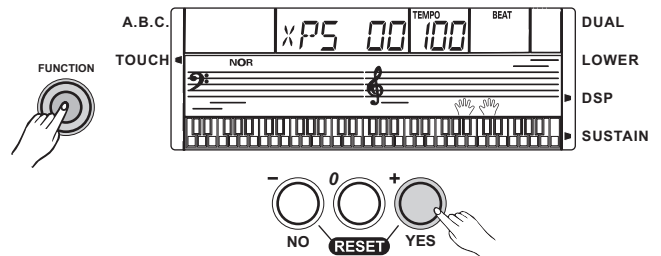

Octave

Press the [FUNCTION] button to enter the OCTAVE sub-menu. The LCD displays the current octave value.

Use [+ / YES] / [- / NO] to adjust the octave value from -1 to 1 octaves.

The default setting is 000.

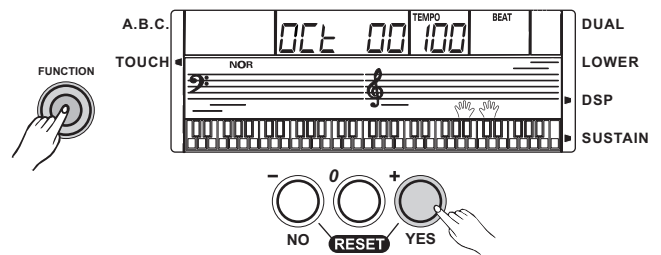

Beat

Press the [FUNCTION] button to enter the BEAT sub-menu. The LCD displays the current beat value.

The LCD displays the current beat value.

Use [+ / YES] / [- / NO] to select the beat value.

The beat value includes: 0, 2-9, 9 types of value.

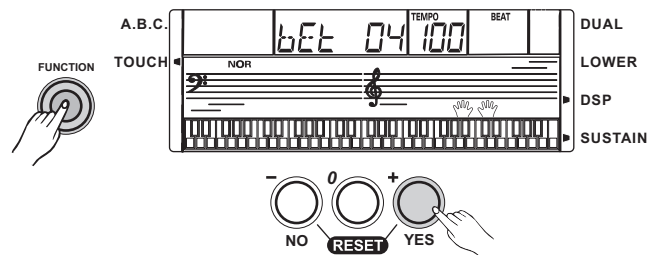

Split Point

Press the [FUNCTION] button to enter SPLIT POINT sub-menu. The LCD displays the current split point value.

Use [+ / YES] / [- / NO] button to adjust the split point value from 1 to 61. The keyboard can be also used to change the split point.

The key of the split point is the part of the left area. The default setting is 019.

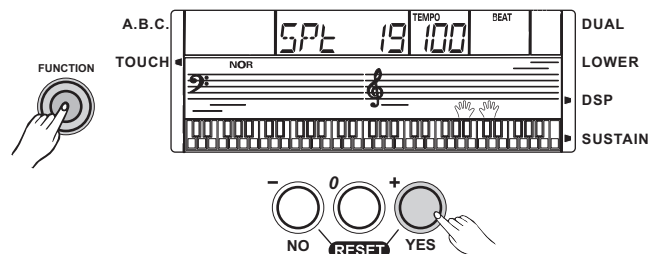

MIDI IN

RECEIVE can be used to set the channel of MIDI IN. Channel 1-16 can be selected by pressing [+ / YES] / [- / NO] button.

The default setting is ALL.

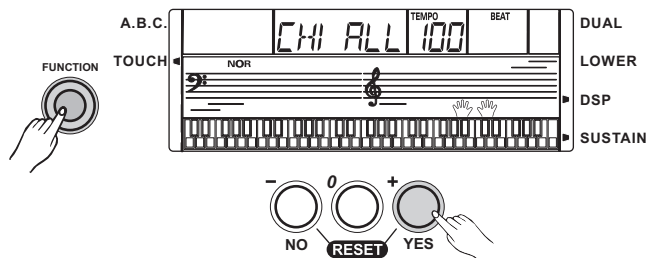

MIDI OUT

TRANSMIT can be used to set the channel of MIDI OUT. Channel 1-16 can be selected by pressing [+ / YES] / [- / NO] button.

The default setting is 001.

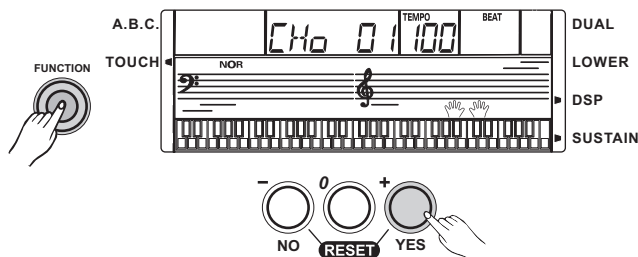

Touch

Press [FUNCTION] button to enter the TOUCH sub-menu. The LCD displays the current touch level.

Use [+ / YES] / [- / NO] button to select touch level from off to level 3. If the value is set as OFF, that means no touch response to keyboard, and LCD darkens "TOUCH" flag.

Default level of touch response is 002.

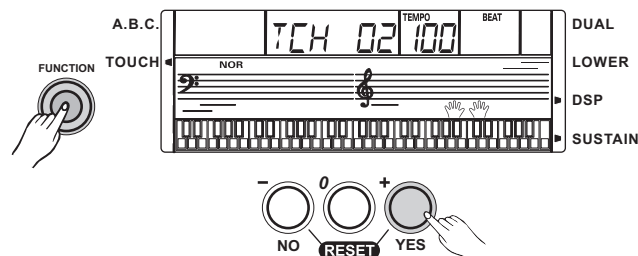

Tune

Press [FUNCTION] button to enter the TUNE sub-menu. The LCD displays the current tune value.

Use [+ / YES] / [- / NO] button to adjust the tune value from -50 to 50 (stand for -100 to 100 cents)

The default setting is 000.

NOTE:

This setting will be effective to both voice and style.

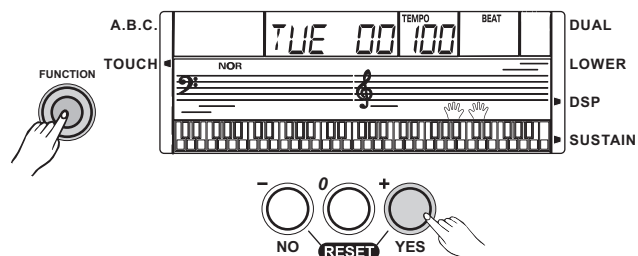

Reverb Level

Press [FUNCTION] button to enter the REVERB LEVEL sub-menu. The LCD displays the current reverb level.

Use [+ / YES] / [- / NO] button to adjust the level from 0 to 127, the default level is 045.

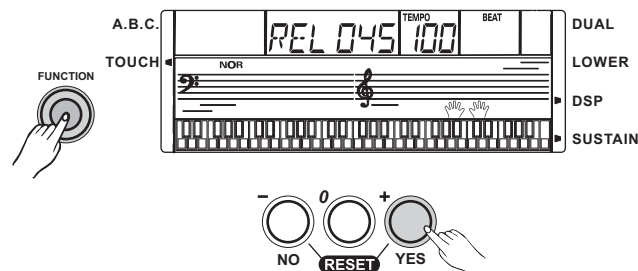

Function Menu

Chorus Level

Press [FUNCTION] button to enter the CHORUS LEVEL sub-menu. The LCD displays the current chorus level.

Use [+ / YES] / [- / NO] button to adjust the chorus level from 0 to 127.

The default level is 000.

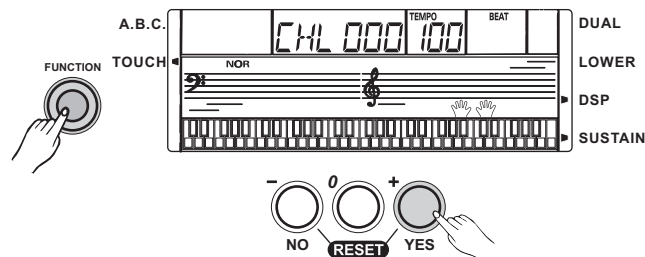

Pedal Assign

Press [FUNCTION] button to enter the PEDAL ASSIGN sub-menu. The LCD displays the type of pedal.

Use [+ / YES] / [- / NO] button to select the pedal type.

The pedal type includes: pedal sustain, pedal soft and pedal start/stop.

The default type is pedal sustain.

Pedal Sustain

If pedal assign is set as "pedal sustain", step on the sustain pedal, all notes on the played on the keyboard have a longer sustain.

Pedal Soft

If pedal assign is set as "pedal soft", step on the soft pedal, all notes on the played on the keyboard have a soft effect.

Pedal Start/Stop

If pedal assign is set as "pedal start/stop", the pedal will have the same function as [START/STOP] button.

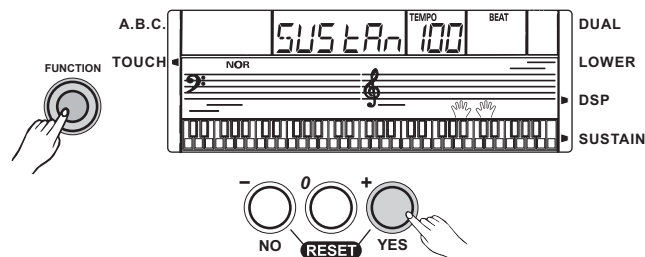

Chord Dictionary

If you know the name of a chord but don't know how to play it, you can use the Chord Dictionary function.

1. In song mode (when song is not playing), Press and hold [CHORD DICT./R] button 2 seconds to enter the DICT mode.

The LCD shows "diCt". In this mode, the keyboard notes in the right area can be played to assign the Chord Type and the Chord Root.

2. For example, if we want to play a Cm7 Chord. Press the C key in the section of the keyboard labeled Chord Root. (The note does not sound).

The root note you set will be shown on the display.

Press the m7 key in the section of the keyboard which has labeled Chord Type (The note does not sound). The notes you should play for the specified chord (root note and chord type) are shown on the display as the notation and also in the keyboard diagram.

3. When the Chord Type and Chord Root are confirmed, the LCD will display the Chord and its keyboard position. A bell sound will be heard if you play it correctly.

4. Press [CHORD DICT./R] button again to exit the Chord Dictionary mode.

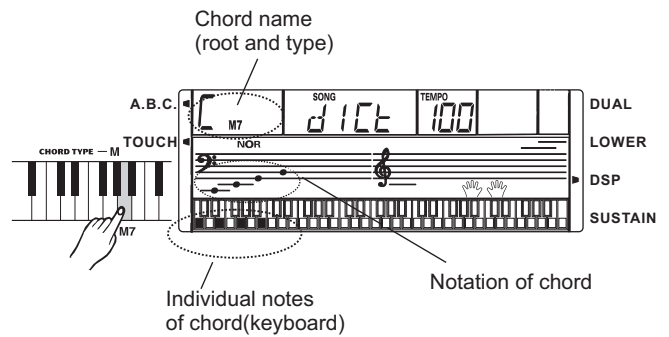
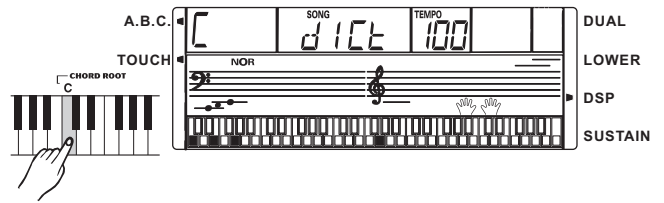
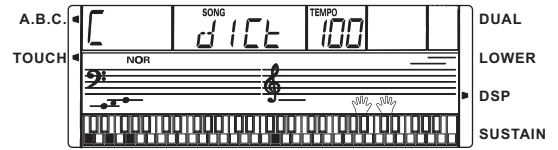
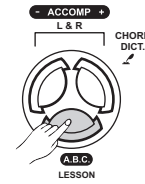

NOTE:

The notes you played in order to assign as the Chord Type / Chord Root could not be heard.

If you play the chord correctly, you could hear the clap sound.

If the chords are not be played correctly, a bass sound would be heard.

The chord should be played below the split point(chord area).

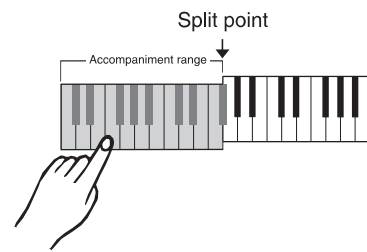

The Chord Type and Chord Root are indicated as the follows:

Chord Root :

NOTE	Chord root	NOTE	Chord root
C6	C	F#6	F#Gb
C#6	C#/Db	G6	G
D6	D	Ab6	Ab/G#
Eb6	Eb/D#	A6	A
E6	C6	Bb6	Bb/A#
F6	F	B6	B

Chord type:

NOTE	Chord type	NOTE	Chord type
C4	M	C5	7(b9)
C#4	m(9)	C#5	7(9)
D4	6	D5	7(#9)
Eb4	mM7	Eb5	7(b13)
E4	M7	E5	7(13)
F4	m	F5	7(#11)
F#4	m(9)	F#5	dim7
G4	m6	G5	dim
Ab4	m7(9)	Ab5	7aug
A4	m7	A5	aug
Bb4	m7b5	Bb5	7sus4
B4	7	B5	sus4

MIDI Function

What is MIDI

1. MIDI stands for "Musical Instrument Digital Interface", that is the standard interface between a PC and other electronic instrument(s).
2. USB connection can be used for midi data transference with a computer or other USB host devices that support USB audio devices.
3. The keyboard can only be connected to the PC.
4. Use the keyboard as a tone generator, the data (MIDI) recorded on the PC can be played on the keyboard.

NOTE:

While a recorded data and a style are being played, you can not use the MIDI IN function, or the song you are playing will have an error occurs for the same channel.

USB Connection

1. System Requirements

- CPU: 300 MHz or higher, Pentium 2
- Memory: 64MB or more
- Driver: CDROM 24X
- OS: WINDOWS 2000/XP

2. The Method of Connection

Connect a standard USB cable between the rear-panel of the USB jack of this instrument and the USB jack of your computer (USB cable will be sold separately).

3. USB Precautions

Please observe the following precautions while connecting the instrument with the a computer via a USB cable. Failure to do, so can cause the instrument and/or the computer to hang up(freeze), possibly causing corruption or losing the data.

If the instrument or computer hangs up, turn the power of both devices off and then turn it on again after a few

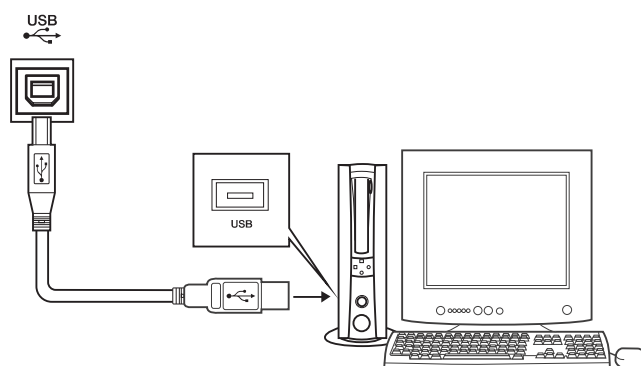

MIDI Application

1. PC recorded data (MIDI) can be played on the keyboard.
2. You need not to install the USB Driver for WINDOWS 2000/XP.

Specifications

LCD display	Multi-functional LCD
Keys	61 keys with Touch Response
Polyphony	32-note polyphony(max)
Voice	300 Voices
Style	100 Styles
Demo Song	100 Songs; 10 Demos
Control button	Master Volume, Tempo +/-, R / Accomp+/Chord Dict., A.B.C/Lesson, Rec/Play, Metro, Voice, Style, Song, Fuction, Start/Stop, Sync, Intro/Ending, Fill, Dual, Touch, Sustain, Dsp, Demo, O.T.S., +/YES, -/NO
Accompaniment Control	Start/Stop, Sync, Intro/Ending, Fill
Song Control	Start/Stop ►■ , Pause ■■ , Rew◀◀ , FF▶▶
Record Function	Record
Power Supply	≡ 9V
Connectors	AC Power, Headphones, Sustain, USB
Speaker	4 Ω 3w x 2
Dimension	940(W)x356(D)x136(H)mm
Weight	3.75kg(without batteries)
Attachment	Music stand, Manual

Appendix 1- Voice List

NO.	NAME	NO.	NAME	NO.	NAME	NO.	NAME
PIANO		41	Dark Celesta	82	Tango Accordion	122	Slap Bass 2
01	Acoustic Grand Piano	42	Celesta & Sine	83	Dark Tango Accordion	123	Slap Bass 3
02	Piano Dark	43	Reecho Bell	GUITAR		124	Slap Bass 4
03	Octave Piano 1	44	Celesta & Music Box	84	Nylon Guitar	125	Synth Bass 1
04	Octave Piano 2	45	Glockenspiel	85	Chorus Nylon Guitar	126	Synth Bass 2
05	Piano & Choir	46	Glockenspiel & Sine	86	Stereo Nylon Guitar	127	Synth Bass 3
06	Grand Piano / W	47	Music Box	87	Steel Guitar	128	Synth Bass 4
07	Bright Piano 1	48	Vibraphone	88	12 String Guitar	STRINGS	
08	Bright Piano	49	Vibraphone / W	89	Detuned Steel Guitar	129	Violin 1
09	Stereo Bright Piano	50	Vibraphone & Bell	90	Jazz Guitar	130	Violin 2
10	Detuned Piano	51	Vibraphone & Harpsichord	91	Clean Guitar	131	2 Violin
11	Chorus Piano	52	Marimba	92	Stereo Clean Guitar	132	Viola 1
12	Bright Piano 1 / W	53	Marimba	93	Soft Clean Guitar	133	Viola 2
13	Bright Piano 2 / W	54	Sine Marimba	94	Chord Clean Guitar	134	2 Viola
14	Piano & Vibraphone	55	Stereo Marimba	95	Muted Guitar	135	Cello 1
15	Electric Grand Piano	56	Marimba & Vibraphone	96	Stereo Muted Guitar	136	Cello 2
16	Electric Grand Piano / W	57	Wood Drum	97	Chord Muted Guitar	137	Contrabass 1
17	Honky-Tonk Piano	58	Xylophone	98	Overdrive Guitar	138	Contrabass 2
18	Honky-Tonk Dark	59	Tubular Bells 1	99	Distortion Guitar	139	Tremolo Strings 1
19	Honky-Tonk 1 / W	60	Tubular Bells 2	100	Guitar Harmonics	140	Tremolo Strings 2
20	Honky-Tonk 2 / W	61	Tubular Bells 3	BASS		141	Pizzicato Strings 1
21	E.Piano 1	62	Dulcimer	101	Acoustic Bass 1	142	Pizzicato Strings 2
22	Stereo E.Piano 1	ORGAN		102	Acoustic Bass 2	143	Orchestral Harp 1
23	50's E.Piano	63	Drawbar Organ	103	Acoustic Bass Detuned	144	Orchestral Harp 2
24	E.Piano 1 / W	64	Drawbar Organ Stereo	104	Velocity Crossfade Bass	145	Stereo Harp
25	E.Piano 2 / W	65	Soft Stereo Drawbar Organ	105	Jazz Style	146	Timpani 1
26	E.Piano 3 / W	66	Mellow Drawbar Organ	106	A.Bass & Mute G.T.	147	Timpani 2
27	E.Piano 4 / W	67	Bright Drawbar Organ	107	Finger Bass 1	STRINGS ENSEMBLE	
28	E.Piano 2	68	Percussive Organ	108	Finger Bass 2	148	Strings Ensemble 1
29	Detuned E.P. 1	69	Percussive Organ Detuned	109	Dark Finger Bass	149	Strings Ensemble 2
30	Detuned E.P. 2	70	Rock Organ	110	Detuned Finger Bass	150	Stereo Strings 1
31	Harpsichord	71	Church Organ	111	Velocity Bass	151	Stereo Strings 2
32	Harpsichord / W	72	Detuned Church Organ	112	Bass & Distortion Guitar	152	Synth Strings 1
33	Harpsichord Octave 1	73	Octave Church Organ 1	113	Pick Bass 1	153	Synth Strings 2
34	Harpsichord Octave 2	74	Octave Church Organ 2	114	Pick Bass 2	154	Synth Strings 3
35	Harpsichord Off	75	Reed Organ	115	Mute Pick Bass	155	Stereo Synth Strings 1
36	Clavichord	76	Stereo Reed Organ	116	Pick & Finger Bass	156	Stereo Synth Strings 2
37	Stereo Clavic	77	Accordion 1	117	Pick Bass & Clean Guitar	157	Choir Aahs
38	Clavichord / W	78	Accordion 2	118	Detuned Pick Bass	158	Dark Aahs
39	Clavichord Wah	79	Stereo Accordion	119	Fretless Bass 1	159	Stereo Aahs 1
MALLET		80	Harmonica	120	Fretless Bass 2	160	Stereo Aahs 2
40	Celesta	81	Dark Harmonica	121	Slap Bass 1	161	Mellow Choir Aahs

Appendix 1- Voice List

NO.	NAME	NO.	NAME	NO.	NAME	NO.	NAME
162	Aahs & SynStr	202	English Horn 2	242	Voice Lead 2	280	Tinkle Bell
163	Big Aahs	203	Bassoon 1	243	Fifths Lead	281	Agogo
164	Voice Ooh	204	Bassoon 2	244	Bass & Lead 1	282	Steel Drums
165	SynthVoice 1	205	Clarinet 1	245	Bass & Lead 2	283	Bass Drum
166	Synth Voice 2	206	Clarinet 2	PAD		284	Wood Block
167	Stereo Synth Voice	PIPE		246	New Age Pad 1	285	Snare
168	Orchestra Hit	207	Piccolo	247	New Age Pad 2	286	Taiko Drum
169	Orchestra Hit Stereo	208	Flute 1	248	Warm Pad 1	287	Melodic Tom
170	Orchestra Hit Octave	209	Flute 2	249	Warm Pad 2	288	Synth Drum
BRASS		210	Recorder 1	250	Poly Synth Pad 1	289	Reverse Cymbal
171	Trumpet 1	211	Recorder 2	251	Poly Synth Pad 2	290	Chinkle
172	Trumpet 2	212	Pan Flute 1	252	Choir Pad 1	SYNTH	
173	Dark Trumpet	213	Pan Flute 2	253	Choir Pad 2	291	Synth 1
174	Wah Trumpet	214	Blown Bottle 1	254	Bowed Pad 1	292	Synth 2
175	Trombone 1	215	Blown Bottle 2	255	Bowed Pad 2	293	Synth 3
176	Trombone 2	216	Shakuhachi 1	256	Metallic Pad	294	Synth 4
177	Tuba 1	217	Shakuhachi 2	257	Halo Pad	295	Synth 5
178	Tuba 2	218	Whistle 1	258	Sweep Pad	296	Synth 6
179	Muted Trumpet 1	219	Whistle 2	EFFECT		297	Synth 7
180	Muted Trumpet 2	220	Ocarina 1	259	Rain	DRUM SET	
181	Horn 1	221	Ocarina 2	260	Soundtrack	298	Standard Drum Set
182	Horn 2	LEAD		261	Crystal	299	Rock Drum Set
183	5th Horn Orchestra	222	Square Lead 1	262	Atmosphere	300	Electronic Drum Set
184	Brass Ensemble	223	Square Lead 2	263	Brightness		
185	Synth Brass 1	224	Square Lead 3	264	Goblins		
186	Synth Brass 2	225	Lead Sine	265	Echoes		
187	Synth Brass 3	226	Slow Square Lead	266	Sci-Fi		
188	Synth Brass 4	227	Thick Square	ETHNIC			
189	Synth Brass 5	228	Quint	267	Sitar		
190	Octave Synth Brass	229	Sine Solo	268	Detuned Sitar		
REED		230	Sawtooth Lead 1	269	Banjo 1		
191	Soprano Sax 1	231	Sawtooth Lead 2	270	Banjo 2		
192	Soprano Sax 2	232	Stereo Sawtooth 1	271	Shamisen 1		
193	Alto Sax 1	233	Stereo Sawtooth 2	272	Shamisen 2		
194	Alto Sax 2	234	5th Sawtooth	273	Koto 1		
195	Tenor Sax 1	235	Calliope Lead 1	274	Koto 2		
196	Tenor Sax 2	236	Calliope Lead 2	275	Kalimba 1		
197	Baritone Sax 1	237	Chiff Lead 1	276	Kalimba 2		
198	Baritone Sax 2	238	Chiff Lead 2	277	Bagpipe		
199	Oboe	239	Charang Lead 1	278	Fiddle		
200	Sweet Oboe	240	Charang Lead 2	279	Shania		
201	English Horn 1	241	Voice Lead 1	PERCUSSIVE			

Appendix 2- Style List

NO.	NAME	NO.	NAME	NO.	NAME	NO.	NAME
BEAT & POP		27	Rock Shuffle	52	Swing Fox	78	Jazz Samba
01	8 Beat 1	28	Charlston	53	Big Band	79	Reggae
02	8 Beat 2	DANCE		54	Big Band Meduim	80	Pop Reggae
03	8 Beat 3	29	Disco 1	55	Jazz Waltz	TRADITIONAL	
04	8 Beat 4	30	Disco 2	56	Ragtime	81	March 1
05	60's 8 Beat	31	Disco Funk	57	Dixeland	82	March 2
06	8 Beat Ballad	32	Dance	58	Quick Step	83	German March
07	8 Beat Rock	33	House 1	COUNTRY		84	6/8 March
08	16 Beat 1	34	House 2	59	Country 1	85	Polka
09	16 Beat 2	35	Rap	60	Country2	86	Pop Polka
10	16 Beat Pop	36	Euro Beat	61	Pop Country	87	Waltz
11	16 Beat Shuffle	37	Hip Hop	62	Country Rock	88	Slow Waltz
12	Ballad	38	Techno	63	Country Folk	89	Vienna Waltz
13	Slow Ballad	SOUL & FUNK		64	3/4 Country	90	Musette
14	16 Beat Ballad	39	Funky Pop	65	Country Waltz	PIANO	
15	Unplugged	40	Jazz Funk	66	Country Shuffle	91	8 Beat
ROCK		41	Cool Funky	67	Country Boogie	92	Ballad
16	Rock	42	Soul 1	68	Country Blues	93	Boogie
17	Pop Rock	43	Soul 2	69	Country QuickStep	94	Jazz
18	Fast Rock	44	Soul Shuffle	70	Bluegrass	95	Swing
19	Slow Rock 1	45	Soul Blues	LATIN		96	Jazz Waltz
20	Slow Rock 2	46	R & B	71	Bossa Nova 1	97	Twist
21	Rock & Roll	47	6/8 Gospel	72	Bossa Nova 2	98	March
22	Heavy Metal	48	Pop Groove	73	Rhumba	99	6/8 March
23	Blues Boogie	JAZZ		74	Pop Rhumba	100	Waltz
24	Blues	49	Swing	75	Cha Cha		
25	Shuffle	50	Cool Jazz	76	Pop Cha Cha		
26	Blues Shuffle	51	Pop Swing	77	Tango		

Appendix 3- Demo List

NO.	NAME
01	Samba
02	Cannon
03	When Johnny Comes Marching Home
04	Butterfly
05	Toy Symphony
06	In The Rain
07	Minuet
08	The Old Gray Mare
09	Turkey In The Straw
10	Cielito Lindo

Appendix 4- Song List

NO.	NAME	NO.	NAME	NO.	NAME	NO.	NAME
CLASSIC		26	Deck The Halls	52	When The Saints Go Marching In	78	La Cucaracha
01	Cannon	27	Grandfather's Clock	53	Twinkle Twinkle Little Star	79	Home Sweet Home
02	Thais Meditation	28	America The Beautiful	54	Happy Birthday To You	80	Up On The House Top
03	Old France	29	The Sideway	55	Little Brown Jug	BALLROOM	
04	Minuet	30	The Entertainer	56	Michael Row The Boat Ashore	81	Kuerchake Dance
05	Ode To Joy	31	The Old Gray Mare	57	Old King Cole	82	Samba
06	Wiegenlied	32	Aloha Oe	58	Jamaica Farewell	83	Tango Of Cuba
07	The "Surprise" Symphony	33	Solveig's Song	59	Тройка	84	Russian
8	Swan Lake	34	Camptown Races	60	Cielito Lindo	85	Polka
9	Spring From "The Four Seasons"	35	Carry Me Back To Old Viginia	61	If You're Happy And You Know It, Clap Your Hands	PIANO & KEYBOARD	
10	Habanera From "Carmen"	36	The Blue-Bells Of Scotland	62	American Patrol	86	Four Little Swans
11	Joy To The World	37	O Sole Mio	63	When Johnny Comes Marching Home	87	Did You Ever See a Lassie
12	Toy Symphony	38	Jingle Bells	64	Green Sleeves	88	Spring
13	Humoreske	39	Battle Hymne Of The Republic	65	Santa Lucia	89	Impromptu
14	Kuckuckswalze	40	Silent Night	66	Szla Dzieweczka	90	Gavotte
FAVORITE		FOLK		KID'S SONG		91	Nocturne
15	Long, Long Ago	41	Огонек	67	Angels We Have Heard On High	92	Pizzicato Polka
16	Old Folks At Home	42	Aula Lee	68	Skip To My Lou	93	Musical Moments
17	Oh! Susanna	43	House Of The Rising Sun	69	London Bridge Is Falling Down	94	Reggae
18	Jeannie With The Light Brown Hair	44	Danny Boy	70	Humpty Dumpty	95	All Kind Of My Everything
19	Bill Bailey Won't You Come Home	45	I've Been Working On The Railroad	71	Home On The Range	96	Valse No.6 "Petit Chien"
20	Annie Laurie	46	In The Rain	72	This Old Man	97	Rondeau
21	From The New World	47	She Wore A Yellow Ribbon	73	Butterfly	98	Chrysanf
22	The Yellow Rose Of Texas	48	My Bonnie	74	Ten Little Indians	99	Invention a 2 Voix
23	Ave Maria	49	Yankee Doodle	75	Polly-Wolly-Doodle	100	Jesus, Saviour Pilot Me
24	My Old Kentucky Home	50	Red River Valley	76	Santa Claus Is Coming To Town		
25	Turkey In The Straw	51	Auld Lang Syne	77	Sippin'Cider Through A Straw		

Appendix 5- Chord List

NO.	Chord Name / [Abbreviation]	Normal Voicing	Chord (C)	Display	NO.	Chord Name / [Abbreviation]	Normal Voicing	Chord (C)	Display
0	Major [M]	1-3-5	C	C	16	Minor major ninth [mM9]	1-2-b3-(5)-7	CmM9	CmM7(9)
01	Major sixth [6]	1-(3)-5-6	C6	C6	17	Diminished [dim]	1-b3-b5	Cdim	Cdim
02	Major seventh [M7]	1-3-(5)-7	CM7	CM7	18	Diminished seventh [dim7]	1-b3-b5-6	Cdim7	Cdim7
03	Major seventh sharp eleventh [M7#11]	1-(2)-3-#4-(5)-7	CM7#11	CM7#11	19	Seventh [7]	1-3-(5)-b7	C7	C7
04	Major add ninth [Madd9]	1-2-3-5	Cmadd9	CM(9)	20	Seventh suspended fourth [7sus4]	1-4-5-b7	C7sus4	C7sus4
05	Major ninth [M9]	1-2-3-(5)-7	CM9	CM7(9)	21	Seventh flatted fifth [7b5]	1-3-b5-b7	C7b5	C7b5
06	Major sixth add ninth [6 9]	1-2-3-(5)-6	C6 9	C6(9)	22	Seventh ninth [7 9]	1-2-3-(5)-b7	C7 9	C7 9
07	Augmented [aug]	1-3-#5	Caug	Caug	23	Seventh sharp evelenth [7#11]	1-2-3-#4-(5)-b7 or 1-(2)-3-#4-5-b7	C7#11	C7#11
08	Minor [m]	1-b3-5	Cm	Cm	24	Seventh thirteenth [7 13]	1-3-(5)-6-b7 or 2-3-5-6-b7	C7 13	C7 13
09	Minor sixth [m6]	1-b3-5-6	Cm6	Cm6	25	Seventh flatted ninth [7b9]	1-b2-3-(5)-b7	C7b9	C7b9
10	Minor seventh [m7]	1-b3-(5)-b7	Cm7	Cm7	26	Seventh flatted thirteenth [7b13]	1-3-5-b6-b7	C7b13	C7b13
11	Minor seventh flatted fifth [m7b5]	1-b3-b5-b7	Cm7b5	Cm7b5	27	Seventh sharp ninth [7#9]	(1)-#2-3-(5)-b7	C7#9	C7#9
12	Minor add ninth [madd9]	1-2-b3-5	Cmadd9	CM(9)	28	Major seventh augmented [M7aug]	1-3-#5-7	CM7aug	CM7aug
13	Minor ninth [m9]	1-2-b3-(5)-b7	Cm9	CM7(9)	29	Seventh augmented [7aug]	(1)-3-#5-b7	C7aug	C7aug
14	Minor eleventh [m11]	1-(2)-b3-4-5-(b7)	Cm11	CM7(11)	30	Suspended fourth [sus4]	1-4-5	Csus4	Csus4
15	Minor major ninth [mM7]	1-b3-(5)-7	CmM7	CmM7	31	One plus two plus five [1+2+5]	1-2-5	C1+2+5	C

Appendix 6- MIDI List

Function		Transmitted	Recognized	Remarks
Basic Channel	Default Changed	1ch 1-16ch	ALL 1-16ch	
Mode	Default Messages Altered	X X *****	3 3 X	
Note Number	True voice	0-127 *****	0...127 0...127	
Velocity :	Note on Note off	O 9nH,V=1-127 X (9nH,V=0)	O 9nH,V=1-127 X (9nH,V=0; 8nH,V=0-127)	
After Touch	Keys Chs	X X	X X	
Pitch Bend		O	O	
Control Change	0 1 5 6 7 10 11 64 65 66 67 80 81 91 93 120 121 123	O X X O O X X O X X O O O O X X O	O O O O O O O O O O O O O O O O O	Bank Select Modulation Portamento Time Data Entry Volume Pan Expression Sustain Pedal Portamento ON/OFF Sostenuto Pedal Soft Pedal Reverb Program Chorus Program Reverb Level Chorus Level All Sound Off Reset All Controllers All Notes Off
Program Change :	true #	O *****	O 0...127	
System Exclusive		X	O	
System Common	: Song Position : Song Select : Tune	X X X	X X X	
System Real Time	:Clock :Commands	X X *1	X X *1	
Aux Messages	:LOCAL ON/OFF :All Notes Off :Active sense :Reset	X O X X	X O O O	
Note:		*1 When the accompaniment is started, an FAH message is transmitted. When accompaniment is stopped, an FCH message is transmitted. When an FAH message is received, accompaniment is started. When an FCH message is received, accompaniment is stopped.		

Mode 1: OMNI ON , POLY Mode 2 : OMNI ON , MONO O : YES
 Mode 3: OMNI OFF , POLY Mode 4 : OMNI OFF , MONO X : NO

