

# NORDOST

MAKING THE CONNECTION

## Nordost Sort Kones

### Rethinking Equipment Support

When it comes to hi-fi equipment supports we have tended to think in terms of isolation – racks, shelves or cone type devices that seek to protect our electronics from the damaging effects of air or structure borne vibrational energy. After all, it's an understandably intuitive response given the presence of at least two very loud speakers in close proximity with the other equipment.

However, recent independent research into the influence of cable and support systems demonstrates that actually, internally generated microphony is a far more significant problem. Internal components such as optical drives and power transformers generate considerable amounts of mechanical energy, but what we tend to overlook is that almost every component in the circuit that charges and discharges or passes signal will also be prone to vibrating. Now, whilst the actual level of mechanical energy in question is often very small indeed, it is also coexists in the same mechanical space as the fragile audio signal – in same cases in the very same component.

The most successful equipment support strategies are designed to deal specifically with draining this energy out of your electronics and into the supporting structure – and that's exactly what the Sort Kones do.

### Why Sort?

Sort is Danish for black – and black is what you get from the Sort Kones. Placing them under your electronics will produce a significant drop in noise floor, a blacker background to your music. The instruments will gain colour and textural detail while music becomes more alive, dynamic and performances more dramatic. All because the haze that was obscuring that level of detail, that was confusing the precise timing relationships between instruments, has been reduced. In this case, black really is the new black.

### Four Levels Of Performance

The Sort Kones are available individually and in four different material combinations. Each molded housing contains a three part, mechanically tuned structure that is designed to drain the mechanical energy generated by the operation of your electronic equipment. In each case, a vertical post is supported by a ball bearing, itself resting on a base element machined from the same material as the post. The different combinations are as follows:

**AS** – aircraft grade aluminum post and base, used in conjunction with a high-grade steel ball.

**AC** – the same metal parts as the AS cone, but employing a ceramic ball instead.

**BC** – bronze is substituted for the aluminum, but with the same ceramic ball, giving significant gains in dynamic range and tonal colour.

**TC** – the ultimate Sort Kone, using titanium metal parts with the ceramic ball. Brings breathtaking weight and presence to recordings.

### How To Use Sort Kones

Nordost Sort Kones are designed for placing between audio electronics and their supporting surface. They bypass the existing feet (normally made of rubber) to create a more efficient exit route for internal mechanical energy. They can be used to augment the performance of an existing audiophile rack, or in conjunction with normal furniture. They can also be used beneath large power amps, which are often placed directly on the floor.

You will need a minimum of three Sort Kones to support each item of electronics in your system. Start by switching off the unit under which you are going to place the Kones. The Sort Kones should be positioned so that their flattened “points” contact the base-plate of the unit, their wider bases being stably supported by the shelf or other surface on which the unit previously sat. When placing the Kones, avoid fixings, screws or bolt-heads in the underside of the unit and keep them clear of the existing feet. Make sure that the equipment is stable on the three Kones before switching it back on.

The performance will be influenced by the precise placement of the Kones. You should seek to position them directly beneath the largest energy source(s) in each item of electronics. These are generally any transport or power supply elements.

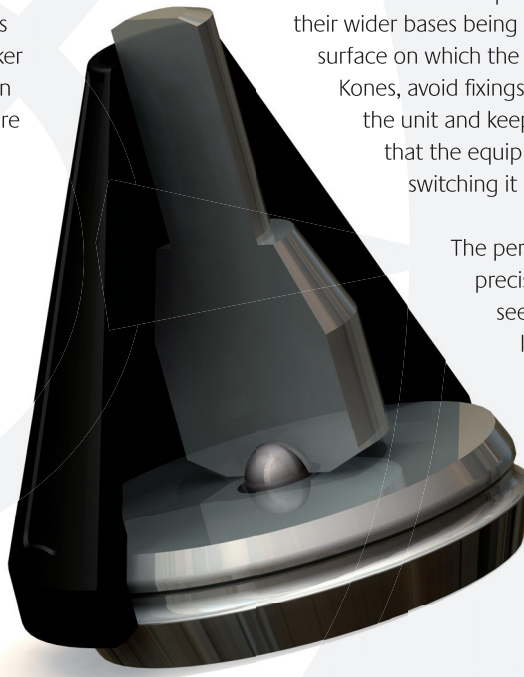

### CD Players

Place one cone directly under the transport, the second under the power supply (generally close to the AC input) and a third to balance the unit safely. CD players with tube output stages will often benefit from a Kone positioned underneath the tubes themselves.

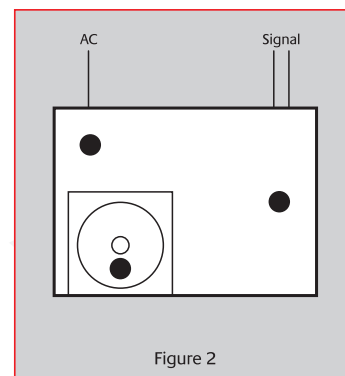
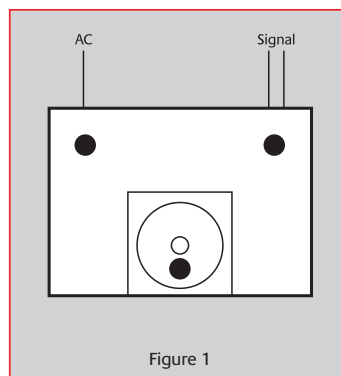

### Integrated Amplifiers

First priority will be the power transformer, with the other two Kones arranged to provide stable support. If possible place one Kone under any tubes employed.

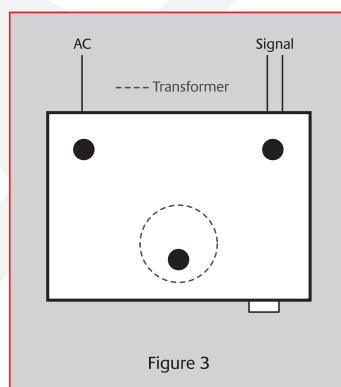

### Pre-Amps

These should be treated in the same way as integrated amps. However, those with external power supplies will require some experimentation. For the pre-amp itself, a good starting point is to place two Kones towards the rear of the unit with a single one placed centrally towards the front, while the power supply should again follow the rules for integrated amps.

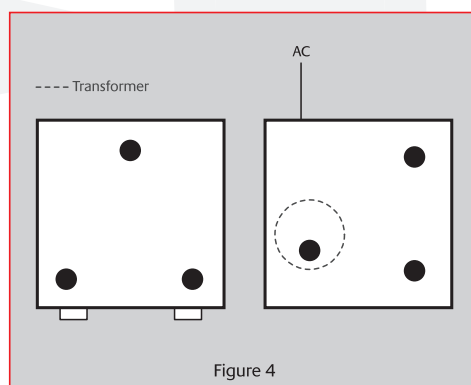

### Power Amplifiers

The first Kone should be placed beneath the power transformer, the others beneath the output stage(s) in such a way to balance the unit. If there are two power transformers, either place one Kone centrally between them or use two Kones under the transformers and the third to balance the unit. With tube amps, place at least one Kone under the output tubes. With a tube mono-bloc, if practical place the third Kone under the output transformer, although often this will depend on the weight distribution of the unit itself.

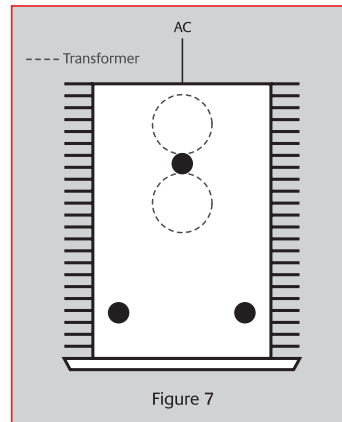

Figure 7

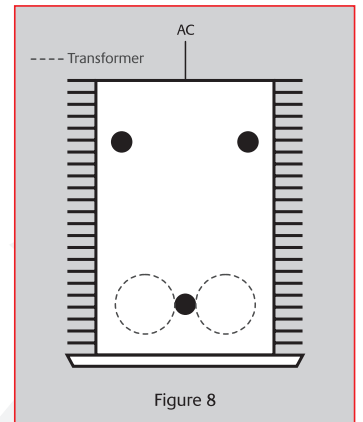

Figure 8

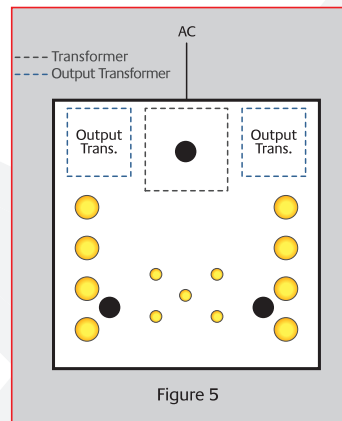

Figure 5

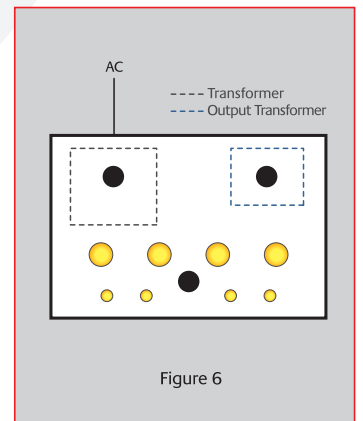

Figure 6

### Ringing the changes...

The basic rules outlined above should allow you to establish the optimum placement for any type of equipment, although it is always worth experimenting. Sometimes, moving a Kone by as little as half an inch can create a very worthwhile improvement. Likewise, the physical structure of a product can also effect the ideal placement, sometimes with unforeseen results so, if you find an alternative placement superior, then stick with it. These suggestions will serve as a useful starting point, but they far from perfect or universal.

### Taking Things Further...

Whilst using three Sort Kones will produce excellent results, you can improve things still further by adding extra Kones. But rather than simply placing four Kones in a symmetrical arrangement, we'd suggest an alternative approach. Very few pieces of equipment have a chassis that is sufficiently stiff or strong enough to resist twisting, especially those containing large power or output transformers. Place them on three Kones and the chassis will almost certainly bow in one direction or another. The way to add a fourth Kone to the set up is to start by supporting the unit on three Kones and then taking the fourth, slide it around beneath the unit until it "grounds" on a low point in the base-plate. This will be under tension and form a vibrational node for mechanical energy, so placing your fourth Kone here will prove most effective, even if it isn't pleasingly symmetrical. In fact, you can extend the approach and add a fifth Kone, a measure that is particularly effective under large, stereo tube amps, with their three large transformers.

Although the Sort Kones are available individually, we would not recommend mixing and matching the different Kones under a single unit. However, there is of course a benefit to be had by prioritizing your primary reproductive chain and using higher grade Kones in these critical applications.

### Further Information

Sort Kones are available through all Nordost authorized dealers and distributors, who can advise on their application to your specific equipment and system.

If you would like additional information or advice please contact Nordost Customer Services at [sales@nordost.com](mailto:sales@nordost.com) or call +1-508-881-1116.

