

Bowers & Wilkins

# Panorama 3

## Welcome to Bowers & Wilkins and Panorama 3

When John Bowers first established Bowers & Wilkins he did so in the belief that imaginative design, innovative engineering and advanced technology were keys that could unlock the enjoyment of audio in the home. That belief continues to inspire every product we design.

Panorama 3 is a network-connected, wireless active speaker that provides extremely high performance. Panorama 3 is primarily intended to be configured and controlled using the Bowers & Wilkins Music App. The app is available for both iOS and Android™ devices. Some commonly used control functions are also available via touch buttons on the Panorama 3 rear panel. It is only possible to install and configure a Panorama 3 using the Bowers & Wilkins Music App.

Panorama 3 will enable you to:

- Listen to audio from TVs via an HDMI® ARC/eARC connection.
- Listen to audio from TVs via a digital audio optical connection.
- Listen to audio from streaming services like Tidal, Qobuz, Deezer, Spotify®, Apple Music and many others.
- Listen to audio over Bluetooth® from appropriately enabled Bluetooth source devices.
- Listen to audio playing anywhere in your home on any compatible Bowers & Wilkins wireless speaker connected to your home network.\*

The Bowers & Wilkins Music App is required to connect your Panorama 3 to your home network and establish connection with other products in your home. The Bowers & Wilkins Music App also provides some control and configuration functions during use. Before you begin your Panorama 3 installation, please download and install the Bowers & Wilkins Music App on your iOS or Android device. The Bowers & Wilkins Music App requires iOS 11.4 or later, or Android V8.1 or later. Bluetooth and WiFi services must be enabled on your iOS or Android device. You will also need to know your WiFi network password.

*Note: Location Services must be enabled on Android devices during the setup process. This is because compatible Bowers & Wilkins products use a low power form of Bluetooth (BT-LE) for service communication, which on Android devices is only enabled when Location Services are allowed. Bowers & Wilkins do not use any location services data for marketing purposes.*

\* Feature to be enabled in 2022

## 1. Carton Contents

Panorama 3  
Power cable  
HDMI cable  
Wall bracket  
Literature pack

## 2. Installing Your Panorama 3

Your Panorama 3 is designed to work with your TV and therefore needs to be located close to your TV. When connected to the TV, the Panorama 3 requires both an HDMI connection and a mains power supply to operate, so it must be located within reach of a mains socket and HDMI connection. If your Panorama 3 is to use a wired connection to your home network, it will need to be located within reach of an appropriate network (Ethernet) cable and use a USB-C to Ethernet adaptor – see section 2.1.

Your Panorama 3 can be placed on a shelf, table or furniture unit, or it can be wall-mounted on the dedicated wall bracket which is included with the Panorama 3. If you decide to place your Panorama 3 on a shelf, ensure that the shelf is easily able to support the weight. The audio performance may be diminished if mounting furniture or shelf panels are flimsy or resonant.

*Note: If your Panorama 3 is to be mounted on a wall bracket, be sure to install the bracket in line with its included instructions. If you are unsure of the suitability of a wall, or of your ability to install the wall bracket, you should engage specialist help.*

Like the vast majority of speakers, your Panorama 3 radiates sound energy not only forward but also to the top, side and rear. Consequently, if your Panorama 3 is positioned close to room boundaries, or particularly in a corner, bass may become over-emphasised. If you find that bass from your Panorama 3 is too prominent, moving it to an alternative position may be beneficial, or you can lower the bass level via the Bowers & Wilkins Music App Settings menu.

### 2.1 Connections

In addition to a mains power socket, your Panorama 3 speaker also has an HDMI ARC/eARC connection, optical audio connection and a USB-C connection for service. It is possible to connect the Panorama 3 to a wired (Ethernet) connection with the use of an Ethernet-to-USB-C adaptor (not supplied).

*Note: Please connect your WiFi or wired LAN to a commercially available router that is certified as telecommunications terminal equipment.*

The primary recommended connection to a TV is with the HDMI connection, and we recommend that you connect the Panorama 3 to your TV's ARC or eARC socket. If your TV does not have an ARC or eARC enabled HDMI connection, then you can connect the Panorama 3 to the TV with the optical digital audio connection.

*Note: To get the best functionality and performance from your Panorama 3 with your TV, we recommend that you enable ARC (and eARC if available on your TV) and CEC. Every TV brand will have a different way to enable these features, and we recommend referring to your TV manual for more information. We also recommend setting the TV to pass-through or bypass mode to*

*enjoy the best audio performance from Dolby® Atmos®-enabled content from other devices connected to your TV.*

### 2.2 Initial Connection

With all connections made, the Bowers & Wilkins Music App installed on your mobile device and your TV configured to work with the selected connection method, your Panorama 3 is ready to be set up.

Your Panorama 3 has no mains power switch and once connected to mains will run a short start-up routine before being ready to use. The start-up routine includes booting up the speaker, connecting to the network and establishing a link to any streaming services and, therefore, can take some time to complete. During this time the Multifunction button will flash white during boot up and orange when establishing a network connection. An audio prompt will play when the start-up routine is complete.

When a Panorama 3 that has not been previously used is first switched on, it will automatically enter setup mode to enable its connection to your home network. Setup mode is indicated by a slow amber pulse illumination of the Multifunction button (see Diagram 1). The Panorama 3 will also appear in the Bowers & Wilkins Music App as available for set-up, either as a pop-up or after selecting 'Add Product' from the app settings page.

Your Panorama 3 manages its operational state and power consumption entirely automatically and will switch to a power saving mode after twenty minutes of inactivity. There is no need to ever switch off your Panorama 3; however, should you wish to do so, simply disconnect it from mains power. Your Panorama 3 will retain its settings without mains power.

### 3. Restarting / Rebooting

You can restart a Panorama 3 speaker with a short press and release of the Reset button located on its rear panel (see Diagram 1). Pressing the button will reboot the Panorama 3 off and on again. All settings will be retained when your Panorama 3 restarts. You can also restart your Panorama 3 via the Bowers & Wilkins Music App settings page.

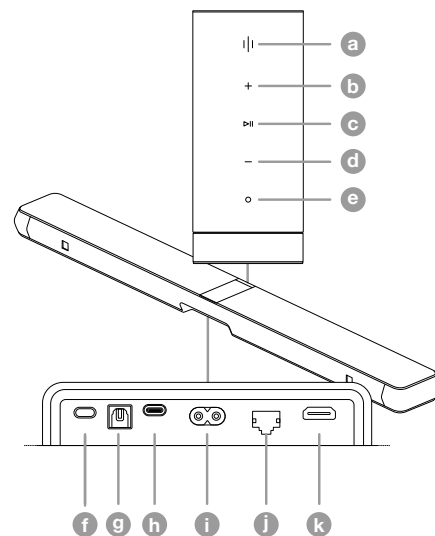

Diagram 1  
Panorama 3 control panel and connectors

## 4. Factory Reset

If you wish to reset your Panorama 3 to its factory default settings, press and hold the Reset button for five seconds. The Reset button location can be seen in Diagram 1. The reset process will be indicated by a red Multifunction button and an audio queue; this process will shut down the Panorama 3. On restart, your Panorama 3 will enter setup mode. All settings will be deleted when your Panorama 3 resets. You can also reset your Panorama 3 via the Bowers & Wilkins Music App Settings menu.

## 5. Setting up on a Network

With your Panorama 3 in setup mode and with its Multifunction button pulsing slowly amber, launch the Bowers & Wilkins Music App on your iOS or Android device. The app will guide you with prompts through the setup process.

*Note: Panorama 3 employs a Bluetooth connection to the device running the Bowers & Wilkins Music App during the setup process. Bluetooth signals have a relatively short range and can be interrupted by room boundaries, so we recommend that your Panorama 3 and Bowers & Wilkins Music App device remain close to the product during the setup process.*

The Bowers & Wilkins Music App requires you to create a user account. When you first download the app, you will be asked to sign into your account if you already have one or create an account. You will need to input a username and password. You can also modify the notifications for your account before setting up. Once you have created an account, you will need to validate the email address by clicking the link that will have been sent to your email address.

The Bowers & Wilkins Music App will first search for any products in setup mode and then will automatically prompt you to start the setup process. Alternatively, you can set up a new product from the settings menu by selecting 'Add product' under the 'Your devices' section.

### Buttons / Connectors

- a Multifunction
- b Volume Up
- c Play/Pause
- d Volume Down
- e Voice Assistant
- f Reset
- g Digital Input
- h Service
- i Power
- j Ethernet
- k HDMI (ARC/eARC)

The setup process in the Bowers & Wilkins Music App will ask you to name the 'Space' in which your Panorama 3 is to be used. A list of suggested space names is provided but you can also create your own. When you have selected or created a space name, the app will ask you to press the Multifunction button on the top of your Panorama 3 to confirm the selection.

If a wireless network connection for your Panorama 3 is to be used, the next setup stage is to connect your Panorama 3 to your home WiFi network. The app will ask you to confirm the correct WiFi network and ask you to input its password. Alternatively, if your Panorama 3 is connected to your network router using an Ethernet cable and a USB-C to Ethernet adaptor, this stage of the setup process will be bypassed.

*Note: If you already have other Bowers & Wilkins-compatible products connected to your WiFi network, the Panorama 3 will not require you to input your WiFi password as this will be shared securely via the Quick Connect function.*

With WiFi network configuration and space selection complete, you will need to configure the input you have selected for the connection to the TV. The app will step you through setting up your TV. If you have connected to the TV with HDMI ARC/eARC, the Bowers & Wilkins Music App will show you how to connect the Panorama 3 to the TV and enable CEC. This allows you to control the audio on the Panorama 3 with your TV or set-top box remote control. If you have connected the TV with the optical connector, the Bowers & Wilkins Music App will show you how to connect the Panorama 3 to the TV and disable the TV's internal speakers. You will next be asked if you want the Panorama 3 to learn the IR commands of your TV remote, allowing you to control the Panorama 3 with this remote.

*Note: If the Panorama 3 does not receive IR commands during the setup process, you may need to enable IR support on external devices on your TV. Please refer to your TV manual for further information.*

## 6. Standalone Bluetooth Setup

It is possible to use your Panorama 3 over Bluetooth without the need to connect the product to a network. With your Panorama 3 in setup mode – indicated by the Multifunction button pulsing slowly amber – press and hold the Multifunction button for 5 seconds. The Panorama 3 will play an audio prompt and the Multifunction button will flash blue. This indicates that the Panorama 3 is in Bluetooth pairing mode and can be connected to via your source device's Bluetooth menu. The Panorama 3 will be available in the Bluetooth menu under the name 'Panorama 3'.

*Note: In this configuration, the product can no longer be set up onto a network. To connect the Panorama 3 onto a network when in Standalone Bluetooth mode, you will need to perform a factory reset of the product via the Reset button on the rear of the product (see section 4).*

The Panorama 3 can be paired with multiple devices by pressing and holding the Multifunction button for 5 seconds to enter pairing mode. The Panorama 3 can support pairing with up to eight devices.

*Note: The Panorama 3 will remain in pairing mode for 2 minutes and time out if no device is*

*paired within that time. To re-enter pairing mode press and hold the Multifunction button.*

## 7. Using Your Panorama 3

### 7.1 Spaces

Spaces are a core concept of the Bowers & Wilkins Music App and compatible products. A 'Space' is a room or a specific area in your home in which you listen to music. It is not possible to use the Panorama 3 with any other device in the same space.

### 7.2 Dolby Support

The Panorama 3 will support Dolby Digital audio in the following formats:

- Dolby Digital
- Dolby Digital Plus™
- Dolby Atmos
- Dolby TrueHD

For all of these audio formats, the Panorama 3 will automatically optimise playback and provide the best audio performance possible.

### 7.3 Streaming Music

You can use your Panorama 3 to play audio from streaming services such as Spotify, Apple Music, Qobuz and Tidal. These can be streamed directly from the Bowers & Wilkins Music App, Spotify Connect®, AirPlay® 2 or Bluetooth.

### 7.4 Playing Audio via the Bowers & Wilkins Music App

Once you have connected to your product and enabled a music streaming service in the Bowers & Wilkins Music App, you can browse music from your streaming service. Once you have selected the track you want to play, simply click the 'Play' button. If you only have a single space, the music will automatically play in that space. If you have multiple spaces, clicking 'Play' will display a list of the available spaces in your home, and selecting a space will play the audio through the selected space.

### 7.5 Playing Audio via Spotify Connect

Use your phone, tablet or computer as a remote control for Spotify. Go to <https://www.spotify.com/> connect to learn how.

### 7.6 Playing Audio via AirPlay

AirPlay enables apps on Apple mobile, laptop or desktop devices to stream audio over a network to any AirPlay-compatible speakers, such as Panorama 3. AirPlay-enabled apps will display the AirPlay icon.

To use AirPlay, open the app you wish to use and select the content you wish to play. Tap on the AirPlay icon to display a list of available devices followed by the space name you wish to use.

## 7.7 Playing Audio via Bluetooth

Bluetooth enables audio apps on mobile, laptop or desktop devices to stream material over a wireless connection to your Panorama 3.

To use Bluetooth, you will first need to pair your device to the Panorama 3. On the Bowers & Wilkins Music App, select Settings and then select the space that contains the device you want to pair with. Selecting 'Pair new device' will put the Panorama 3 into Bluetooth pairing mode. Go to the Bluetooth menu of your device and pair it with the Panorama 3. The Panorama 3 will use the space name in the Bluetooth pairing menu. Once paired, you can play audio via any app on your source device. You can see a list of the devices paired to your Panorama 3 in the Bowers & Wilkins Music App.

*Note: The Panorama 3 will remain in pairing mode for 2 minutes and time out if no device is paired within that time. To re-enter pairing mode, repeat the steps above.*

## 8. Bowers & Wilkins Music App

The Bowers & Wilkins Music App opens on the main page. At the bottom of the page are four navigation icons for the main sections of the app: browse, library, search and settings. The icon illuminated in yellow indicates which page you are on.

### 8.1 Browse

The browse page of the Bowers & Wilkins Music App has content arranged in multiple rows in a ribbon view that you can search through by swiping right and left. The browse page shows recommended playlists that are generated based on your musical taste, your recently played music and some recommended playlists curated by Bowers & Wilkins. You can also scroll down and browse music from any specific streaming services you have linked to your app.

*Note: The recommendations are based on the genres, artists, albums and tracks that you have liked. To like any material, simply click the heart symbol. The more you like, the better the recommendations will be. Your recommendations will stay with you and your Bowers & Wilkins account and are not linked to your music streaming service.*

### 8.2 Library

The library page groups together all the material that you have liked either in the Bowers & Wilkins Music App or in any of your streaming services. You can search content here by music, podcasts and radio. If you have liked material in a streaming service native app, it may not appear in the Bowers & Wilkins Music App Library straight away.

### 8.3 Search

You can search for any music via the search function in the Bowers & Wilkins Music App. The app will search for results from all your linked streaming services.

## 8.4 Settings

The settings pages allow you to configure multiple products within your home. The settings page is split into different sections:

- **Your Spaces**  
This section lists all the spaces within your home and from this you can configure individual devices.
- **Your Account**  
This section allows you to modify your account details and link any music services to your app.
- **Your Products**  
This is where you can trigger any updates that are available for any of your products in your home.

## 8.5 Linking Streaming Services

The Bowers & Wilkins Music App enables you to select and play music from a number of streaming services, such as Qobuz, Tidal, Deezer and many more. To do this, the Bowers & Wilkins Music App needs to be linked to your music streaming service. This can be done in settings via the 'Link Services' button in 'Your Account'. Simply tap and follow the on-screen instructions.

## 8.6 Player View

When audio is playing on the Panorama 3, you can control the volume, play/pause the audio, skip forward and skip back. The Player view can be minimised by pressing the down arrow on the top left of the screen. This minimises the player view to the bottom of the main screen. This can be maximised by tapping on the mini player view at any time.

## 9. Software Update

Panorama 3 is a network-connected speaker and, as such, reliability improvements, new functions and new features can be enabled via software updates. When a software update is available for any product on your network, a tag is marked on the settings icon. Going to the settings page will display the available update. Tapping this will trigger an update for all the products on the network that require an update.

## 10. Audio Adjustments

The placement of any speaker can have an impact on the audio. Placing a speaker close to a wall can over-emphasize the bass, and if the speaker is not facing you, the high frequency content can be lowered. Therefore, it is possible to adjust the bass and treble settings of your Panorama 3 to allow greater flexibility in positioning within your room. To access these settings, select Settings and then the name of the space with the product you wish to adjust, then select the device. You can then adjust the bass and treble from -6dB to +6dB. The settings will be stored by the Panorama 3 when the power is disconnected but will be reset after a factory reset.

## 11. Amazon Alexa

The Panorama 3 is a smart speaker with the Amazon Alexa voice assistant inbuilt. To enable this feature, go to the device level settings page within the

Bowers & Wilkins Music App. Select Settings and then choose the space containing the Panorama 3 on which you wish to enable the voice assistant. Next, select the device. The device settings page will be displayed. You can enable Amazon Alexa here by linking to your Amazon account: simply click the link and follow the instructions. You can unlink your Panorama 3 from your Alexa account at any time.

To talk to Alexa, simply say the trigger word, 'Alexa' or press the Voice Service button on the Panorama 3. Pressing and holding the Voice Service button will mute the Alexa microphones.

## 12. Panorama 3 Controls

Your Panorama 3 has buttons on the upper rear panel that provide play/pause control, volume adjustment and voice assistant – see Diagram 1.

Pressing Play/Pause will alternately stop and restart audio playback.

Pressing Volume Up (+) or Volume Down (-) will adjust the volume of any audio that is being played. Pressing and holding the + and - buttons will continuously increase or decrease volume.

Touching the Multifunction button will cycle through and play the active streams and sources available to the Panorama 3. The Panorama 3 Multifunction button illumination changes to indicate a variety of operational states. The illuminations are displayed in Diagram 2.

Pressing the Voice Service button allows you to talk to the voice assistant without needing to say the trigger word. This functionality requires a voice service to be enabled on your Panorama 3.

## 13. Cleaning

Should your Panorama 3 need cleaning, you can wipe its top surface with a clean, lint-free cloth and brush its grille with a soft brush. If you wish to use any cleaning fluid, apply it onto the cleaning cloth and not directly onto the Panorama 3. Test a small area first, as some cleaning products may damage some of the surfaces. Avoid products that are abrasive, or contain acid, alkali or antibacterial agents.

## 14. Support

Should you require further help or advice regarding your product, please visit the support site: [www.bowerswilkins.com/support](http://www.bowerswilkins.com/support).

## 15. Environmental Information

This product automatically manages its power state without the need for any interaction. When connected to a network and not in use, power consumption is automatically reduced below 2 watts.

This product complies with international directives, including but not limited to the Restriction of Hazardous Substances (RoHS) in electrical and electronic equipment, the Registration, Evaluation, Authorisation and restriction of Chemicals (REACH) and the disposal of Waste Electrical and Electronic Equipment (WEEE). Consult your local waste disposal authority for guidance on how properly to recycle or dispose of this product.









Illumination		Operational state
Flashing white		Start-up in progress
Pulsing amber		Ready for setup
Flashing amber		Firmware update in progress
Pulsing white		Audio pull in progress
Pulsing red		Error – contact support
Solid red		Error – contact support
Flashing red		Factory reset in progress
Flashing blue		Bluetooth pairing mode
Solid blue		Bluetooth connection established

Diagram 2  
Multifunction indicator illuminations

## Specifications

Technical Features	Compatible with Bowers & Wilkins Music App Apple AirPlay 2 Spotify Connect Bluetooth Alexa enabled Dolby TrueHD Discrete Dolby Atmos 3.1.2 HDMI eARC
Audio Format Support	Dolby Atmos Dolby Digital True HD Dolby Digital Plus LPCM
Bluetooth	5.0, class 2
Bluetooth Codecs	aptX™ Adaptive AAC SBC
AirPlay 2 Compatibility	iPhone, iPad, and iPod touch with iOS 11.4 or later, Apple TV 4K or Apple TV (4th Generation) with tvOS 11.4 or later, Mac or PC with iTunes 12.8 or later
Amplifier Power Output	400W
Drive Units	3x 19mm (0.75") Titanium dome tweeter 6x 50mm (2") Woven glass fibre cone bass/midrange 2x 50mm (2") Woven glass fibre cone atmos drive unit 2x 100mm (4") Low profile bass unit
Frequency Response	43Hz–48kHz
Dimensions	65mm (h) x 1210mm (w) x 140mm (d)
Weight	6.5kg
Connections	1x HDMI ARC/eARC 1x Digital Audio In (Toslink) 1x RJ45 Ethernet 1x USB-C (service only)
Input Voltage	100V–240V, 50/60Hz
Standby Power Consumption	Below 2 watts

The terms HDMI and HDMI High-Definition Multimedia Interface, and the HDMI Logo are trademarks or registered trademarks of HDMI Licensing Administrator, Inc. in the United States and other countries. Dolby, Dolby Atmos and Dolby Digital Plus are registered trademarks of Dolby Laboratories. Apple, AirPlay, Apple Music, iOS, iPhone, iPad, iPod touch, iTunes, Apple TV, Mac, macOS, OS X, and tvOS are registered trademarks of Apple Inc., registered in the U.S. and other countries. The trademark "iPhone" is used in Japan with a license from Aiphone KK. Spotify and Spotify Connect are trademarks of Spotify AB. Spotify Connect availability may depend on your region, please check [www.spotify.com](http://www.spotify.com) for more details. Amazon, Alexa, and all related logos are trademarks of Amazon.com, Inc. or its affiliates. Amazon, Android is a trademark of Google LLC. aptX is a product of Qualcomm Technologies, Inc. and/or its subsidiaries. aptX is a trademark of Qualcomm Technologies International, Ltd., registered in the United States and other countries. The Bluetooth word mark and logos are registered trademarks owned by the Bluetooth SIG, Inc. and any use of such marks by Bowers & Wilkins is under license. Other trademarks and trade names are those of their respective owners.