

## User's Guide



# ADI-2 DAC FS

Sonus Verus

32 Bit / 768 kHz  
Hi-Res Audio

**DSD**  
Direct Stream Digital



**SteadyClock FS**



**SyncCheck**

2 Channel Digital / Analog Converter  
SPDIF (AES/ADAT) Interface  
32 Bit / 768 kHz Digital Audio  
USB 2.0 Class Compliant  
Extreme Power Headphone Output  
Super Low Noise IEM Output  
Digital Signal Processing  
Advanced Feature Set  
Extended Remote Control

---

## ► General

<b>1</b>	<b>Introduction</b> .....	5
<b>2</b>	<b>Package Contents</b> .....	5
<b>3</b>	<b>System Requirements</b> .....	5
<b>4</b>	<b>Brief Description and Characteristics</b> .....	6
<b>5</b>	<b>First Usage - Quick Start</b>	
5.1	Connectors and Controls.....	7
5.2	Quick Start.....	7
5.3	Operation at the unit.....	8
5.4	Overview Menu Structure.....	9
5.5	Playback.....	10
5.6	Digital Recording.....	10
<b>6</b>	<b>Power Supply</b> .....	11
<b>7</b>	<b>Firmware Update</b> .....	11
<b>8</b>	<b>Features Explained</b>	
8.1	Extreme Power Headphone Output .....	12
8.2	IEM Headphone Output.....	13
8.3	5-band Parametric EQ .....	13
8.4	Bass / Treble .....	14
8.5	Loudness.....	14
8.6	Crossfeed.....	15
8.7	M/S-Processing.....	15
8.8	DSP Limitations.....	16

## ► Operation, Controls and Display

<b>9</b>	<b>RME Multi-Remote Control (MRC)</b>	
9.1	Keys and Functions.....	18
9.2	Other Remote Controls .....	19
<b>10</b>	<b>Front Panel Controls</b>	
10.1	Keys .....	19
10.2	Encoders .....	19
<b>11</b>	<b>VOL</b> .....	20
<b>12</b>	<b>I/O</b> .....	20
12.1	Subpage Settings.....	21
12.2	Subpage Parametric EQ .....	22
12.3	Subpage Bass / Treble.....	23
12.4	Subpage Loudness .....	23
<b>13</b>	<b>EQ</b> .....	24
<b>14</b>	<b>SETUP</b>	
14.1	Options	
14.1.1	Remap Keys / Diagnosis .....	26
14.1.2	Clock .....	27
14.1.3	Phones / DSD.....	27
14.1.4	Display.....	28
14.1.5	Expert Settings .....	28
14.2	Load/Store all Settings .....	29
<b>15</b>	<b>Top Screens</b>	
15.1	Dark Volume / Details .....	29
15.2	Analyzer.....	30
15.3	State Overview .....	31
<b>16</b>	<b>Warning Messages</b> .....	32
<b>17</b>	<b>DSD Operation</b>	
17.1	General.....	33
17.2	Direct DSD .....	33
17.3	DSD Playback .....	34
17.4	DSD Record .....	34

---

► **Inputs and Outputs**

<b>18</b>	<b>Digital Inputs</b> .....	36
<b>19</b>	<b>Analog Outputs</b>	
19.1	General .....	36
19.2	Line Out RCA .....	36
19.3	Line Out XLR .....	37
19.4	Phones Out .....	37
19.5	IEM Out .....	38
19.6	Using more than one Output .....	38

► **Installation and Operation - Windows**

<b>20</b>	<b>Driver Installation</b> .....	40
<b>21</b>	<b>Configuring the ADI-2 DAC</b>	
21.1	Settings Dialog .....	41
21.2	Clock Modes - Synchronization .....	42
<b>22</b>	<b>Operation and Usage</b>	
22.1	Playback .....	42
22.2	Multi-client Operation .....	42
22.3	Multi-interface Operation .....	43
22.4	ASIO .....	43
<b>23</b>	<b>DIGICheck Windows</b> .....	43

► **Installation and Operation – Mac OS X**

<b>24</b>	<b>General</b> .....	46
24.1	Configuring the ADI-2 DAC .....	46
24.2	Clock Modes - Synchronization .....	46
24.3	Multi-interface Operation .....	47
<b>25</b>	<b>DIGICheck Mac</b> .....	47

► **Installation and Operation – iOS**

<b>26</b>	<b>General</b> .....	50
<b>27</b>	<b>System Requirements</b> .....	50
<b>28</b>	<b>Setup</b> .....	50
<b>29</b>	<b>Supported Inputs and Outputs</b> .....	50

► **Technical Reference**

<b>30</b>	<b>Technical Specifications</b>	
30.1	Digital Inputs .....	52
30.2	Analog Outputs .....	52
30.3	Digital .....	53
30.4	General .....	53
30.5	Connector Pinouts .....	53

---

## 31 Technical Background

31.1	Emphasis .....	54
31.2	SteadyClock FS.....	54
31.3	DA Impulse Responses.....	55
31.4	Filter Curves 44.1 kHz.....	57
31.5	No Content - reserved.....	57
31.6	Loudness.....	57
31.7	Distortion Measurements .....	58
31.8	Extreme Power Charts .....	59
31.9	Phones Distortion Comparison .....	60
31.10	Impedance based Level Meters (Phones) .....	60
31.11	USB Audio (Windows).....	61
31.12	Operation in the Hi-Fi Environment.....	62
31.13	Digital Volume Control.....	63
31.14	Bit Test.....	65
31.15	Block Diagram.....	66

## ► Miscellaneous

32	Accessories .....	68
33	Warranty.....	68
34	Appendix .....	69
35	Declaration of Conformity .....	70

## Note about the current ADI-2 DAC

At the end of 2020 a fire destroyed AKM's production facilities for AD and DA converter chips. A resumption of production and thus availability of these components is not expected before 2022. Therefore, many manufacturers - like RME - are forced to either discontinue products based on AKM chips, or to use other chips for the foreseeable future.

The ADI-2 DAC was initially based on an AK4490, later on the AK4493. The current unit uses an ES9028Q2M for its high-quality DA conversion. This chip is very similar to the AK4493 in features and technical specifications, which allows RME to continue offering the ADI-2 DAC in its well-known supreme quality, and with a nearly identical feature set.

Even though this chip is a central (sometimes sole) quality determining element, the ADI-2 DAC is just not a normal DAC. Tech specs and features are based on RME technologies, and they are available unchanged also with the ESS chip:

- Complete DSP functionality (PEQ, Bass/Treble, Loudness etc.).
- All sample rates, PCM as well as DSD
- All digital formats (SPDIF/AES/ADAT)
- Analog output circuitry, including Auto Ref and 2.5 dB digital headroom
- Very fast switching between different sample rates
- Extreme Power headphone output stage
- SteadyClock FS, including the latest 1 Hz filter technology
- Remote, display, general behavior, operation and handling....

ADI-2 DACs with AK4493 and ES9028Q2M are neither sonically nor visually easily distinguishable. However, the ESS version is recognized by a small C at the end of the serial number sticker (B stood for AKM 4493). Furthermore, the units differ in the available filters. The unit with AKM has a filter called *Short Delay Low Dispersion*, while the one with ESS has a filter called *Brick-wall* (the other filters, SD Sharp, SD Slow, Sharp, Slow, NOS, are identical). Further Chip dependent differences are mentioned in this manual.

But now we wish you exquisite listening pleasure and a lot of fun with the ADI-2 DAC!

---

## 1. Introduction

RME's ADI-2 DAC is a true milestone in many ways. Looking at the multitude of DA converters, USB DACs and dedicated headphone amps available, RME developers felt they all lacked obvious features that are unavoidable to enjoy operation as well as when listening to music. And while many of those devices claim to use the latest state-of-the-art whatsoever converter chip, serious magazines and RME staff were repeatedly disappointed to find that in the end the stellar technical data published in ads and datasheets were nowhere to be found.

With the ever growing popularity of headphones and latest DA chips pushing technical data further, the time was right for a new RME gem. A unit with specs that are as real as RME's reputation, a feature set that is unheard of, useful features that for unknown reasons no one else implemented, and an extremely powerful headphone output that will be your new reference in accuracy and dynamic range.

Here it is – the ADI-2 DAC:

- A high-end DA converter in professional studio quality
- A headphone amplifier in true high-end quality
- A USB DAC like no other - the most versatile and capable one around
- A high-end DAC frontend and headphone amp for iPad and iPhone
- An SPDIF/ADAT playback system
- A DSD playback solution

## 2. Package Contents

- ADI-2 DAC
- Remote control (MRC) with battery
- Manual
- External switched power supply, lockable connector, DC 12 V 24 W
- Power cord
- USB cable, 1.8 m (6 ft)

## 3. System Requirements

General:

- Power supply 12V DC, 1.0 A or up

For computer based operation:

- Windows 7 or up, Intel Mac OS X (10.6 or up)
- 1 USB 2.0 port or USB 3 port
- Computer with at least Intel Core i3 CPU

For iOS based operation:

- iPhone or iPad with iOS 7 or up
- Dock or Lightning to USB adapter

---

## 4. Brief Description and Characteristics

The ADI-2 DAC is a 2-channel digital to analog converter in a half-rack (9.5") enclosure of 1 U height. Latest 32 bit / 768 kHz converters offer up to 120 dBA signal to noise ratio. This value is not only printed in the brochure – it is what the unit achieves in real-world operation.

Reference class tech specs throughout are combined with an unprecedented feature set. A powerful DSP adds all kinds of useful audio processing, including 5-band parametric EQ, fast Bass/Treble adjustment, Crossfeed, and a new concept in Loudness sound control.

Operation is quick and easy through 3 encoders with push button function and 4 more buttons to access dedicated menus. The unit remembers all current settings, even the menu position. Additionally the unit's whole setup as well as equalizer settings can be stored under individual names.

A high resolution IPS panel for the graphical operation surface eases operation even more, and displays further functions provided by the DSP, namely Peak level meters, a 30-band analyzer in DIGICheck biquad filter technology, and a State Overview screen listing the current states of SPDIF, USB and clock.

The digital inputs SPDIF coaxial and optical can be used alternately. SPDIF optical also supports 2 channels of ADAT operation, at up to 192 kHz.

When used as USB interface, Class Compliant UAC 2 enables up to 768 kHz sample rate on an iPad. The same is available on computers for high resolution of PCM, DXD and DSD at up to 768 kHz / DSD256.

The balanced and unbalanced outputs are fitted with both XLR and RCA jacks. The unit uses a fully balanced and DC-coupled circuit design, for highest phase accuracy at lowest roll-off.

The Extreme Power headphone output provides reference sound and headroom. RME's unique IEM output offers unprecedented low noise for latest super-sensitive In-Ear phones.

To maintain the full dynamic range within the best operating level, discrete 4-stage reference level settings were realized for maximum dynamic range (-5, +1, +7, +13 dBu). The digital volume control of the ADI-2 DAC operates distortion free over a range of 190 dB, therefore does not cause any tampering of the sound.

The ADI-2 DAC supports sample rates between 44.1 kHz and 768 kHz. Furthermore, RME's SteadyClock FS guarantees exceptional performance in all clock modes. Thanks to a highly efficient jitter suppression, the DA-conversion always operates on highest sonic level, being completely independent from the quality of the incoming clock signal.

The ADI-2 DAC shines in both studio and home usage. Its click- and noise-free on/off operation and a comfortable, illuminated standby button add to the soft, modern desktop design. An Auto-Dark mode removes all disturbing lights without sacrificing operation and setup. The included remote control offers comfortable control of the ADI-2 DAC directly from the preferred listening position with stellar flexibility through four additional, freely programmable keys.

Battery operated usage is possible through a 12V connector.

---

## 5. First Usage – Quick Start

### 5.1 Connectors and Controls

The **front** of the ADI-2 DAC has 3 hi-precision rotary encoders with push function, 4 buttons, a standby power button, a high resolution IPS display, and two TRS headphone outputs.

The output channels Phones and IEM feed two phones outputs via two independent driver circuits, optimized for both high and low impedance headphones. Their unbalanced output signal is of highest quality. With up to 120 dBA Dynamic Range there exists no audible hum and noise at those outputs.

In case a phones output is to be used as line output, an adapter TRS plug to RCA phono plugs, or TRS plug to two TS plugs is required.

The **rear** of the ADI-2 DAC has 2 RCA sockets as unbalanced outputs and 2 XLR sockets as balanced outputs, TOSLINK optical/coaxial input, a USB socket, and a lockable power socket.

! *The short circuit protected, low impedance **XLR line outputs** do not operate servo balanced! When connecting unbalanced equipment via XLR, make sure pin 3 of the XLR output is not connected. A connection to ground might cause an increase in THD (higher distortion) and power consumption!*

**Optical In (TOSLINK):** The unit automatically detects SPDIF or ADAT input signals. Note that only channels 1/2 from the ADAT stream can be accessed. SMUX and SMUX4 (up to 192 kHz) are still supported.

**USB 2.0:** Standard USB socket for connection to the computer. The ADI-2 DAC operates as Class Compliant device, in 2-channel mode. It can be directly used with Mac OS X and iOS (iPad, iPhone). For Windows the RME MADiface series driver adds WDM and ASIO.

**Socket** for power connection. This socket supports locking type jacks as found on the included RME DC power supply. After inserting the connector carefully turn it by 90° so that it locks.

### 5.2 Quick Start

Connect the unit to the included power supply and push the red lit Standby button to start. The ADI-2 DAC ships with Source Auto (I/O – Line Out – Settings - Source) as default setting.

Remove the transparent plastic isolator by tearing it out of the remote control bottom. Then use the remote to switch to the desired input signal, USB, SPDIF optical or SPDIF coaxial.

Factory default for remote buttons 1 to 4:  
1: Mono, 2: Loudness, 3: AutoDark, 4: Dim

The ADI-2 DAC is a 2-channel I/O interface when connected via USB. Under Windows install the RME WDM/ASIO driver to play back a stereo signal from the computer.

*Source* allows to play back an SPDIF input signal even when USB is connected. When not connected to USB the ADI-2 DAC will work as SPDIF to analog converter. In mode *Source Auto* the input is switched to SPDIF automatically as soon as USB is no longer detected.

The unit remembers all settings, and loads these automatically when it is switched on again. To switch off, press the Standby button for at least 0.5 seconds.

To change between phones and rear output without unplugging phones: change *Mute Line* to Toggle Ph/Line or Toggle Plugged, see chapter 14.1.3.

### 5.3. Operation at the Unit

Useful information for a smooth start:

Turning the big VOLUME knob brings up the Volume screen of the currently active output. The status bar at the bottom of the display shows the current volume setting as dB value.

The header shows the currently selected output, the hardware reference level and Auto Ref Level mode if activated (Ref Lev, see chapter 12.1).

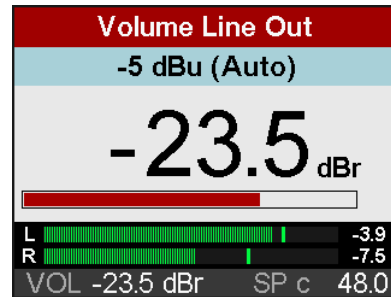

The EQ is set up either directly within the I/O menu structure (key I/O, turn encoder 2 to access Settings, Parametric EQ, Bass/Treble and Loudness), or via the graphical EQ screen which is shown after pressing the EQ key. In this screen the cursor has three positions: top, the EQ parameter line below the Bode plot (frequency response curve), and the filter selection type for band 1 and 5 (Peak, Shelf, Low/High Cut). The cursor is moved up or down by pushing encoder 1 or 2 repeatedly.

With the cursor in the top position only the current band is highlighted (B1...). Turning VOLUME changes the band's gain, pushing it changes to the next band. Switching between the bands can also be done by turning encoder 2.

When in the EQ parameter line, all values are no longer grayed out. In this state the big encoder steers Gain, encoder 1 Frequency, and encoder 2 Quality factor. This way the EQ is extremely fast set up and edited.

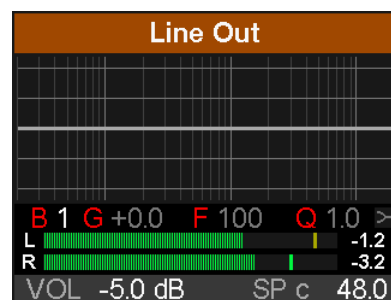

The graph has 5 different colors matching the 5 bands that can be adjusted. If the line is just grey the EQ is disabled (bypass). The EQ can be enabled in the second menu which comes up by pushing the EQ key a second time.

The unit offers four informative screens on the top level: **Analyzer**, **State Overview**, **Dark Volume** and **Dark Volume Details**. Change between them by pushing encoder 1 or 2 whenever any of them is displayed. To quickly call them up simply press any of the four function keys several times.

In all these top level screens turning encoder 1 and 2 brings up the quick access to Bass and Treble, with  $\pm 6$  dB maximum boost/cut.

The included remote control uses a standard lithium battery CR2025. The remote allows to turn the ADI-2 DAC on and off (standby), to change the volume, to mute the output and to select the playback source (SPDIF, optical, USB). Additionally it has four freely programmable keys that can be assigned to 32 different commands/actions (see chapter 14.1.1).



## 5.4. Overview Menu Structure

1 means upper small encoder (B), 2 lower small encoder (T). Rotate moves horizontally, press vertically (1 up, 2 down) through the menu structure. Note: the menu *Expert Settings* is not available in AKM based versions.



---

## 5.5 Playback

In the audio application being used, the ADI-2 DAC must be selected as output device. It can often be found in the *Options*, *Preferences* or *Settings* menus, as *Playback Device*, *Audio Devices*, *Audio* etc. After selecting a device, audio data is sent to the ADI-2 DAC and available at its analog outputs.

Increasing the number and/or size of audio buffers and/or buffer size may prevent the audio signal from breaking up or having drop outs.

## 5.6 Digital Recording

In digital audio, it is mandatory for a unit like the ADI-2 DAC to be in total sync to the external digital device, as so called clock slave. Taking this into account, RME added a comprehensive I/O signal status display to the ADI-2 DAC, showing sample frequency, lock and sync status in the State Overview screen and the bottom status bar.

The sample frequency shown in the State Overview screen is useful as a quick display of the current configuration of the unit and the connected external equipment. If no sample frequency is recognized, it will show - - (No Lock).

This way, configuring any suitable audio application for digital recording is simple. After connecting it the ADI-2 DAC displays the internal and external sample rate. This parameter can then be changed in the application's audio attributes (or similar) dialog.

To enable the recording of the SPDIF input via USB go to I/O, Source, and select either USB (Rec opt.) or USB (Rec coax). *Record SPDIF optical* and *Record SPDIF coaxial* activate the full duplex operation with USB: The respective SPDIF signal is clock source and can be recorded via USB. The analog output signal is now the current USB playback, no longer the SPDIF input signal. For this to work the USB playback sample rate must be identical to the SPDIF input signal.

Note: The option *Loopback to USB* replaces the SPDIF input signal with the USB playback signal, either taken pre or post DSP. The input signal coaxial/optical is then no longer available for recording.

## 6. Power Supply

In order to make operating the ADI-2 DAC as flexible as possible, the unit has a universal DC input socket, accepting voltages from 9.5 Volts up to 15 Volts. An internal switching regulator of the latest technology with high efficiency (> 90%) prevents internal hum noise by operating above audible frequencies. Internally the switching regulator is followed by standard linear regulators, followed by super low-noise linear regulators. Therefore the ADI-2 DAC achieves its technical specs even with less optimal power supplies. Or in other words: the choice of power supply is not critical.

Still the unit includes a high-quality switching power supply, 12 V / 2 A, which not only accepts any mains voltage between 100 V and 240 V (usable world-wide), but is also fully regulated against voltage fluctuations and suppresses line noise. Additionally it only weights 150 g in spite of its high power of 24 Watts.

The DC input of the ADI-2 DAC also allows for the use of a rechargeable lead-battery or LiPo instead of a power supply, for completely independent mobile operation and ground isolation. A matching connection cable (power jack 5.5 x 2.1 mm to terminals 6.3 mm) should be available from various sources. Special power banks in the range of 10,000 mAh and up can be found equipped with a 12 V output. These offer a perfect solution for mobility as well as ground isolated operation, for small money.

---

## 7. Firmware Update

The ADI-2 DAC might receive improved features or bug fixes by a firmware update. This update will be available from the RME website, section Downloads, USB. Download the tool that matches your operating system (Mac or Windows), then unpack the zipped archive.

The Flash Update Tool updates the firmware of the ADI-2 DAC to the latest version. Under Windows it requires an already installed MADIface series driver, which is found on the same download page.

Start the Flash Update Tool. It displays the current revision of the ADI-2 DAC firmware, and whether it needs an update or not. If so, then simply press the 'Update' button. A progress bar will indicate when the flash process is finished (Verify Ok).

After the update the ADI-2 DAC needs to be reset. Push the standby button to switch it off for 5 seconds.

When the update unexpectedly fails (status: failure), the unit's Safety BIOS will be used from the next boot on, the unit stays fully functional. The flash process should then be tried again.

The flash process does not affect user data like sample rate choices, EQ settings or Setups.

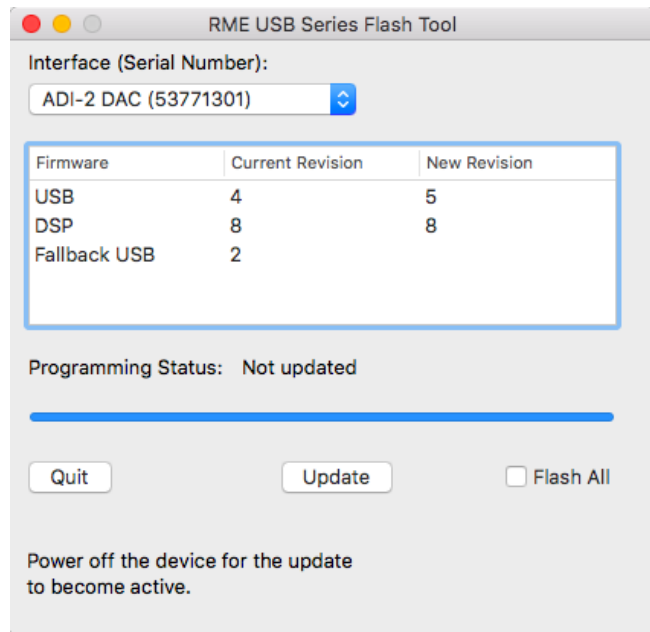

### Returning to Factory State

In case a total reset is desired: hold encoder 1 and the VOL button pushed while turning on the unit. This will reset all current settings to factory default. User-stored Setups and EQ presets are not affected. The same action is performed by loading Factory via Setup Select. Note that the reset will be incomplete when the unit is connected to USB while performing the reset.

When holding encoder 1, 2 and the VOL button pushed while turning on the unit, user-stored Setups and EQ presets are still not affected, but their names are reset as well.

The startup screen shows *Reset Done* when the reset process has been successfully initiated. As soon as the message shows up VOL key and encoder 1 no longer need to be pushed.

---

## 8. Features Explained

### 8.1 Extreme Power Headphone Outputs

During the development of the ADI-2 Pro an extensive research on today's headphone amp technology as well as headphones has been carried out. Many (many!) headphones later a maximum output level of +22 dBu (10 Volt) was set as development goal, as it will drive even insensitive headphones sufficiently, while a maximum output current of around 260 mA per channel will result in lots of power for lower impedance phones (1.5 Watts @ 32 Ohm).

Limiting the current makes a lot of sense. It is needed to control the internal power supply, to not fully overdrive (and destroy) weaker headphones, and prevents malfunction at short-circuit state. The Extreme Power output stage acts like a small power amplifier, so it got a similar feature set: a relay that mutes and interrupts the connection to the phones, a DC sensing circuit to prevent DC at the output (DC destroys your precious phones already when the rated watts are not even closely reached!), and an over-current protection circuit that will notice when a short-circuit causes too high current, preventing the output stage to get destroyed. In light of the malicious treatment of this output stage during development it needs to be mentioned that it can not be destroyed by a short-circuit at the output nor by overheating. Still some extra safety won't hurt, and the over-current protection circuit got in.

A goal during development was to build a headphone amp that not only reaches very low THD un-loaded (the typical way of measuring it), but *very* low THD values with a 32 or 16 ohm real-world load. This was achieved in the new *Extreme Power* headphone driver output stage. It uses 6-fold spread power technology, improved thermal conductivity and a special super-low distortion driver design. The result is THD below -110 dB at 32 Ohm load even near full output level (clipping), the same SNR as the DAC provides (120 dBA), an output impedance of only 0.1 Ohms, totally stable operation, and a frequency response from 0 Hz up to 80 kHz, with just 0.5 dB decrease at the top end. That means: No audible hum, noise or distortion, fully transparent and crystal clear sound at any volume setting, for any personal taste in any application.

And there is more. The headphone sockets of the ADI-2 DAC have sensor contacts. The unit always knows when a headphone jack is inserted or removed. The DSP uses this information for several superior, partly never-seen before features. For example the ADI-2 DAC activates the mute relay half a second after the phones plug has been plugged in, then the DSP ramps up the volume slowly from lower level to the last used state. Comfortable? Luxurious? Yes, but the main reason for it was to give the user a chance to react. Extreme Power headphone outputs set to full output level, music already playing at full level, inserting the phones, and the moment the relay switches on the doctor is called, diagnosing sudden deafness - this should and can not happen with the ADI-2 DAC. When the volume is ramped up one has the time to either quickly set the phones off, unplug the phones again, or to grab the Volume knob to quickly turn it down.

To guarantee that the Volume knob will be set to control the correct outputs in that moment, the DSP also sets the Volume knob automatically to the output where phones had been plugged in. And even returns the setting when the phones are unplugged again.

This is just an example of how intelligent and elaborate the control logic of the ADI-2 DAC has been implemented. There are lots of such functions and features that might even stay unnoticed, making the unit behave fail-proof as well as easy to operate.

But isn't +22 dBu, or Hi-Power as it is called in the menu, much too loud for modern phones? That depends. There are still phones that need higher levels. Music can be low in volume but consume a lot of power, especially with lots of sub-bass. And lots of headroom is always nice to have. Typically with Hi-Power off, which equals +7 dBu maximum output level, modern music and modern headphones, Hi-Power is mostly not needed. But you will notice that even with Hi-Power active, which requires to use a volume setting 15 dB lower as usual, the sound stays the same, and there is no audible noise or hum at the phones output (provided the source is clean, of course). So even at a Volume setting of -40 dB the ADI-2 DAC delivers perfect sound quality, being a no-brainer in daily use as how to set it.

---

## 8.2 IEM Phones Output

In Low Power mode, the Extreme Power design of the ADI-2 DAC turns it into one of the world's lowest noise headphone outputs. However, a few IEMs are so incredibly sensitive (means loud) that, despite all the technical super specs, a faint noise could become audible (current example: Campfire Andromeda, at least 20 dB louder as modern, already as loud categorized headphones).

The usual remedy is the use of an external, passive voltage divider 16 Ohm to 1 Ohm, either self-built, or bought as a pre-made product.

Since IEMs are not only increasingly popular, but are generally more sensitive than normal headphones, and a powerful Extreme Power output stage always entails the risk of destruction of the IEM with wrong settings, the ADI-2 DAC has been equipped with an additional output stage optimized for IEMs. Here, there is no Extreme Power, but extreme noise freedom, with the same sensational low distortion as at the big phones output, but a maximum output level of only -3 dBu. For most users this will suffice even for ordinary headphones, in particular portable ones with the mini TRS connector. This output with < 0.1 Ohms impedance turns the ADI-2 DAC into a reference for all types of headphones, from over-ear planar up to in-ear multi-drivers.

## 8.3 5-band Parametric EQ (PEQ)

While no equalization as well as listening only straight linear has been a mantra for many years, research has proven that no ears are identical, and that especially in near-field listening (with phones) the biological differences alone make individual equalization mandatory. No two pairs of ears hear the same thing, that's a fact. Additionally personal taste makes people like different sound signatures, which can easily be copied or made more similar (equalized...) on different headphones using a good EQ. The advantages of using an EQ outweigh any alleged disadvantages - which so often turn out to be wrong at closer inspection.

Having used PEQ to linearize as well as to better meet personal taste with a variety of headphones, RME found 5 bands of parametric EQ to be the best balance between occupied DSP resources and efficient sound treatment. While it is true that on some phones rebuilding an exact response curve needs more than 5 bands, one quickly realizes that very narrow peaks and notches make no audible difference when compensating them. Their acoustical energy is too low to get audible. Ignoring those narrow peaks/notches and only taking care of deviations that require a quality factor of 3 or below, the 5 band parametric EQ turns into a very efficient tool even for problematic phones.

This is one of the many major features that can't be found on any similar device: a high-quality 5-band parametric EQ, usable at up to 768 kHz sample rate, easy to set up and adjust, with a graphical display showing the resulting curve, and multiple storage places including individual naming. So whatever EQ setting you need, it is loaded and modified quickly. And to make this feature really useful the DAC offers three individual EQ settings - one each for rear out, Phones and IEM.

On a related topic: These days many people suffer from hearing loss in varying degrees. No matter if it is biological, from abuse or an accident - hearing impaired is a plague of modern times. And – no surprise when thinking about it – it never affects both ears identically. The number of people having one sided hearing problems is huge, but they have learned to live with an industry that totally ignores them. Although the solution is as simple as logical – have the EQ be adjustable independently for left and right. Basically digital EQs are calculated this way, the common controls are just for making it easier to operate. The ADI-2 DAC includes an option called *Dual EQ* – a heaven send feature for many, for sure.

Of course a 5-band parametric EQ is also suitable for speaker and room correction, another application where separate EQ left/right setups are necessary. Using the ADI-2 DAC as DAC for the main monitors will benefit from this and all the other typical RME features available on all analog I/Os: Phase and Mono in various options, Width and M/S Processing.

---

## 8.4 Bass / Treble

The simpler form of EQ has been the Bass and Treble controls as they are found on any 'standard' HiFi stereo amplifier. They easily and quickly allow to modify the sound to your personal liking (more or less Bass, more or less Treble, obviously). An even more useful application is to quickly change the amount of Bass / Treble in smaller quantities so that music compilations don't have one song making the cones fall out while another one makes you think that really happened. Producers and mastering engineers not only have their own taste, they also sometimes fail in providing a mix that is on an average sound level compared to others. In that moment a quick turn on the two ADI-2 DAC's small encoders will make the music sound perfect.

These Bass and Treble controls are limited to  $\pm 6$  dB. Everything exceeding such values should be handled by the EQ, and/or calls for better speakers/phones. The corner frequency and quality factor of Bass and Treble is user-adjustable in the display's menu, making this feature even more useful. Adapt it to meet your speakers/phones or your personal taste – it will greatly improve your pleasure in listening to music again.

## 8.5 Loudness

Another legacy of HiFi amplifiers: there has not been a single one missing a feature called *Loudness*. It tries to address the changes in frequency-dependent hearing sensitivity over different volume levels. If one listens to music loud, then drops the level by at least 20 dB, sound loses punch and glitter. HiFi amps tried to fight this effect by adding more bass and treble the lower the volume was set. Unfortunately that never worked as intended, and just became an additional bass/treble booster. Reason: the manufacturer of the HiFi amp could not know what volume any position of the volume knob equals at the customer's home. Room size, room dampening and efficiency of the used speakers are all unknown.

But the effect of loss in perceived sound exists (read about the Fletcher-Munson curves), and can be easily reproduced with any serious gear by comparing normal volume and DIM state (usually -20 dB). The ADI-2 DAC offers Loudness for the analog stereo outputs, and probably is the first time that Loudness works as intended. The user can decide how much maximum gain in Bass and Treble should occur at lower volume settings. The user also sets the Low Vol Reference, where maximum gain is achieved. After extensive tests a 20 dB range has been defined as range for maximum gain to no gain while increasing volume. That seemed to be the perfect definition of the range that needs to be addressed by Loudness.

Here is an example on how it works: the user's typical lowest level listening volume is at -35 dB at the unit. This value is now set by the user as Low Vol Ref in the Loudness menu. Then Bass and Treble Gain can be set between 0 and +10 dB. Default is +7 dB for both. Increasing the volume by turning the Volume knob causes the gain in Bass and Treble to be lowered smoothly over a range of 20 dB. So when Volume is set to -15 dB, the music is not only quite loud, but Loudness' Bass and Treble are then at 0 dB gain. See chapter 31.6 for graphs.

No matter how sensitive the connected phones or speakers are, no matter how much increase in Bass and Treble are desired – with the ADI-2 DAC one can finally adjust it to meet the personal hearing and taste. Loudness finally works as it should have worked from the start - another unique feature in the ADI-2 DAC.

Note: Loudness works best in Auto Ref Level mode due to the seamless dB scale of the volume control. Without Auto Ref Level active, manually changing the Ref Level will change the volume without changing the VOLume value (dB). As Loudness is referenced to a 'Low Vol Ref' setting it then might no longer work as intended, and needs the Low Vol Ref value to be adjusted.

---

## 8.6 Crossfeed

While headphones open the sound stage and make everything easier to hear and to locate by spreading the narrow sound field of stereo speakers to the left/right extreme, some people would like to have a listening situation that is more comparable to a standard speaker setup. The ADI-2 DAC includes Crossfeed to address this wish. Crossfeed reduces the artificial surround ambience that some productions have to make them sound better on speakers, but which sounds unnatural on a headphone.

The Bauer Binaural method is used, with five selectable strengths of narrowing the upper frequencies. This advanced method, which also includes a small delay and correction of the frequency response, works quite well, and is another useful addition as well as a unique feature on a device like the ADI-2 DAC.

### Details on internal settings

The Crossfeed effect is mainly defined by the filter frequency and the amount of crossfeed, here given as damping factor:

- 1: 650 Hz, -13 dB (just a touch)
- 2: 650 Hz, -9.5 dB (Jan Meier emulation)
- 3: 700 Hz, -6 dB (Chu Moy emulation)
- 4: 700 Hz, -4.5 dB (30° 3 meter emulation)
- 5: 700 Hz, -3 dB (example how even stronger would sound)

## 8.7 M/S Processing

The mid/side principle is a special positioning technique for microphones, which results in a mid signal on one channel and a side signal on the other channel. This information can be transformed back into a stereo signal quite easily. The process sends the monaural mid channel to left and right, the side channel too, but phase inverted (180°) to the right channel.

For a better understanding: the mid channel represents the function  $L+R$ , while the side channel represents  $L-R$ .

During record the monitoring needs to be done in 'conventional' stereo. Therefore the ADI-2 DAC also offers the functionality of a M/S-decoder. Activation is done in the Settings menu of Line Out, Phones Out and IEM Out via the option **M/S-Proc**.

The M/S-Processing automatically operates as M/S encoder or decoder, depending on the source signal format. When processing a usual stereo signal, all monaural information will be shifted into the left channel, all stereo information into the right channel (thus the stereo signal is M/S encoded).

This was another reason for RME to offer this option in a 'HiFi-DAC', because the separation of the mono and stereo components provides some interesting insights into the mono/stereo content of modern music productions. Use Balance to switch between left and right only to hear the full details of the result.

---

## 8.8. DSP Limitations

*There is never enough DSP power – no matter how much you add (frustrated developer).*

That is true even for the ADI-2 DAC. Although being equipped with a quite capable 2.17 Giga FLOPS DSP chip, plus using the FPGA to perform further calculations (RME's virtual DSP for mixing/routing, level meters, filtering, Crossfeed), 768 kHz sample rate takes its toll. The calculation power available at 48 kHz is divided by 16 (!) then. Even at 384 kHz it is just 1/8 of that at 48 kHz. The DSP in the ADI-2 Pro performs:

*Bass/Treble and Loudness for 2 channels*

*5-band parametric EQ for 2 channels*

*Standard phase functions for 2 channels*

*Crossfeed for 2 channels*

*30-Band bi-quad bandpass filter spectral analyzer*

*Peak Level meters for all channels*

*Display rendering*

*Volume control on 2 channels*

*Several controller-like functions, like volume ramp-up, mute, signal routing control etc.*

*DSD to PCM conversion (for level meters)*

At 48 kHz that is no big deal, at 192 kHz it already needs efficient coding and a better DSP chip. But at 768 kHz you need a DSP with 4 times the power of the 'better' one. Therefore there is no way around disabling some functions at higher sample rates. Fortunately those limitations have only small impact in real-world usage:

- At sample rates 705.6 kHz and up Crossfeed or EQ can be active, not both at the same time. Bass/Treble and Loudness are not available.

The high sample rates available in the ADI-2 DAC also exceed the capabilities of the digital input. Both AES and SPDIF are limited to 192 kHz, and there is no way around it. Therefore all higher sample rates are only usable with USB. And in iOS mode when using an iPad/iPhone with an app that supports such high sample rates (Neutron, Onkyo HF-Player etc.).

**DSD** comes with its own limitations. DSD is a 1 bit stream of data that can not be processed digitally. There is no Bass, Treble, Loudness, EQ etc. possible at all. The volume control is no longer done by the DSP, but the DAC chip, which converts DSD into PCM to be able to offer level (volume) modification. You won't notice that, volume operation at the ADI-2 DAC is seamless and behaves identical in any mode. The DSP now performs an additional DSD to PCM conversion, to be able to show the audio signal on the level meters and the Analyzer – a unique feature of the ADI-2 DAC.

Even more extreme is **DSD Direct**. If activated (SETUP, Options, Phones / DSD), the DSD signal is not converted to PCM within the DAC chip, therefore there is no volume control at all – except for the analog reference levels, which can be used to set the coarse output level / volume. Left with no volume control, the ADI-2 DAC intentionally deactivates the headphone outputs in DSD Direct mode – the analog signal is only available at the rear outputs.



---

## User's Guide



# ADI-2 DAC

### ▶ Operation, Controls and Display

---

## 9. RME Multi-Remote Control (MRC)

The included infrared remote control, manufactured exclusively for RME, offers an almost complete remote control of the ADI-2 DAC in a clear way. It works immediately without further settings on the device, since the DAC code table is pre-set from factory. Pressing a button therefore causes the SEL LED to light up green. If the LED is orange, red or blue, another reserved code table is active that is not compatible with the ADI-2 DAC.

The code tables are changed as follows:

- Keep SEL pressed until the LED lights up constantly.
- Press button 1. The LED turns green and then off. The remote control now works with the ADI-2 DAC.

Note: *SETUP – Options - Remap Keys/Diagnosis - Remap Keys* must be set to *Remote*.

### 9.1 Keys and Functions

**SEL.** Choice between 4 different code tables. The ADI-2 DAC uses table 1, recognizable by the LED color green.

**Power On/Off.** Press and hold the button for 1 second to switch off.

**B/T.** Bass/Treble active or off (linear).

**EQ.** PEQ active or off (linear).

**LD.** Loudness active or off.

**B+ / - .** Increase or decrease Bass, same as encoder 1.

**+ (VOL) - .** Increase or decrease volume.

**VOL.** Corresponds to pressing the VOLUME button on the unit. Short press results in mute, long press results in output change when configured via *SETUP, Options, Phones / DSD, Mute Line - Toggle Ph/Line*.

**T+ / - .** Increase or decrease Treble, same as encoder 2.

**L / R.** Change balance between left and right.

**COAX. OPT. USB.** Direct selection of the playback source (SPDIF Coaxial, Optical, USB). By pressing the same button twice the ADI-2 DAC activates *Source Auto* mode.

**1, 2, 3, 4.** Remap Function Keys. In the *SETUP, Options, Remap Keys /Diagnosis* menu, 32 different commands/actions are available for these four programmable keys (see chapter 14.1.1). Functions such as polarity, crossfeed or DAC filters can be controlled live from the preferred listening position. The default settings are: 1 Mono, 2 Loudness, 3 AutoDark, 4 Dim.

**Mute.** Mute the audio output.

The remote requires a standard lithium battery CR2025 (included). For first time usage please tear out the transparent plastic isolation completely.



---

## 9.2 Other Remote Controls

The ADI-2 DAC can also be remotely controlled using third-party remote controls and custom IR transmitters. The well-known manufacturer Logitech has added the ADI-2 DAC to its remote control database. Others can use the codes documented here:

[http://www.rme-audio.de/downloads/adi2dac\\_ir\\_commands.zip](http://www.rme-audio.de/downloads/adi2dac_ir_commands.zip)

Available are the original keys of the MRC and all 32 Remap commands with direct access (without remapping).

## 10. Front Panel Controls

General operation and usage of the ADI-2 DAC are explained in chapter 5.2, Quick Start, and chapter 5.3, Operation at the unit.

The ADI-2 DAC ships with *Source: Auto* active.

The *State Overview* screen is especially useful to check the state of digital input signals as well as the current settings with USB. It also displays several warning messages which might explain why currently no sound is audible. See chapter 15.3 for details.

The following chapters explain all the controls and menu items in detail.

### 10.1 Keys

The four back-lit function keys offer quick access of important parameters within the menu structure. After pressing one of the four keys the corresponding menu is shown in the display. The unit remembers the last selection per key, so re-visiting a formerly changed parameter is easy. To leave the menu push the same key a second time, or any other key two times. The display will revert to the top screen that was active before entering the menu.

### 10.2 Encoders

The encoders can be turned endlessly, but also pressed, adding a push button function. The current functionality of all encoders is shown in the display. The big Volume knob usually controls volume for all outputs.

Turning the small encoders 1 and 2 either changes the current parameter, or moves the selection/cursor horizontally to the next page. Pressing the encoders 1 and 2 moves the selection/cursor vertically, up with 1 and down with 2, as indicated by the arrows in the display.

Example: Press the key SETUP. The menu *Setups* is now shown. 1 within the circle on the right side indicates that by turning encoder 1 more pages are available. Turn encoder 1 left to enter *Options*. Now turn encoder 2 to scroll horizontally through all the subpages offered under Options: Remap Keys / Diagnosis, Phones / DSD, Clock. By pressing encoder 2 the cursor moves down, by pressing encoder 1 back up. On a selected field or entry, 2 to the right indicates that the current parameter can be changed by turning encoder 2.

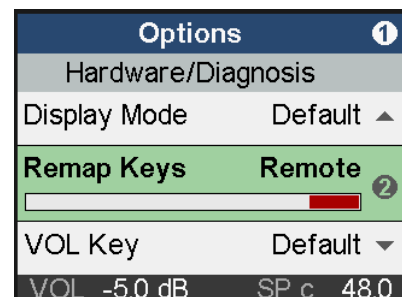

---

## 11. VOL

The VOL key brings up an extended volume screen with balance control. Volume can then be adjusted by both Volume knob and encoder 1. Encoder 2 sets the Balance parameter.

The volume and balance setting is also found in the menu I/O - Settings, at the end of the list.

The status bar at the bottom of the display shows the volume setting's current dB value.

A push on encoder 1 (B) mutes the current output. The text in the blue field shows *Line Out - muted*. A second push exits the mute state.

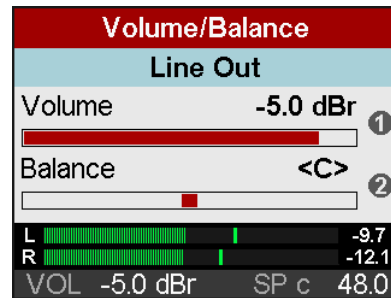

A push on encoder 2 (T) sets Balance to center (<C>)

Pushing the VOL key again reverts to the level meter screen that has been active before.

Line Out defaults to *Auto Ref Level* enabled. The current volume setting is then shown as *dBr* (dB relative), and the unit automatically switches to the matching hardware reference level to optimize the dynamic range.

## 12. I/O

The I/O menu has all the settings for the three analog outputs: *Line Output*, *Phones* and *IEM*. Source defines which signal is fed to the analog outputs – USB, SPDIF optical or SPDIF coaxial. The submenu *Parametric EQ* mirrors the settings done in the graphical EQ screen.

The ADI-2 DAC processes all audio in the digital domain. Having only one stereo digital to analog converter, different settings of volume, equalizer or effects for the three outputs is not possible when used simultaneously (the ADI-2 Pro has two DACs, therefore can process two stereo signals independently with different settings).

But typical operation is alternate usage of the outputs – rear Line Out or Phones or IEM. The ADI-2 DAC treats all outputs separately, and stores a complete set of parameters for each (except the synchronized Source selection). Depending on the used output, detected by the sensor contacts in the output jacks, the respective settings are loaded automatically, and this way the formerly used volume, EQ and much more. In alternate usage the unit thus provides three fully independently to configure outputs.

---

## 12.1 Subpage Settings

### Source

The source of the analog output signal: Auto, SPDIF coax, Optical, USB, USB (Rec coax), USB (Rec opt.). Default: Auto. In Auto Mode any detected SPDIF Signal will have priority over USB playback.

*Record SPDIF optical* and *Record SPDIF Coaxial* activate the full duplex operation with USB: The respective SPDIF signal is clock source and can be recorded via USB. The analog output signal is the current USB playback, in case the sample rate is identical to the SPDIF input.

### Line Output: Ref Level

Sets the reference level for the analog outputs. Choices are -5 dBu, +1 dBu, +7 dBu, +13 dBu at the RCA output, referenced to digital full scale level (0 dBFS). The levels at the XLR output are 6 dB higher, +1 dBu, +7 dBu, +13 dBu, +19 dBu.

### Phones: Hi-Power

OFF, ON. Default: OFF. Reference level for 0 dBFS is +7 dBu at the output. With Hi-Power on reference level is 15 dB higher, +22 dBu.

**IEM: No choice.** The output IEM uses a fixed reference level of -3 dBu.

### Auto Ref Level

ON, Off. Default: ON. See chapter 19.3 for details.

### Mono

OFF, ON, to Left. Default: OFF. The option *to Left* sends the sum of left and right channel to the left output only.

### Width

Defines the stereo width. 1.00 equals full stereo, 0.00 mono, -1.00 swapped channels.

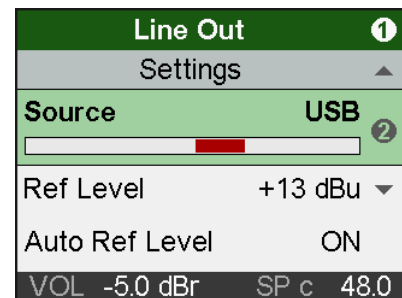

### M/S-Proc

Activates M/S processing. Monaural content is sent to the left, stereo to the right channel.

### Polarity (Phase Invert)

Available settings are Off, Both, Left and Right. Inverts the polarity on the corresponding channel.

### Crossfeed

OFF, 1, 2, 3, 4, 5. The Bauer stereo to Binaural crossfeed effect emulates speaker playback by reducing the stereo width in the treble range. Adjustable in five steps.

### DA Filter

Short Delay Sharp, Short Delay Slow, Sharp, Slow, NOS, SD LD (only AKM), Brickwall (only ESS). The D/A converter offers several reconstruction filters. Default is *SD Sharp*, offering the most linear frequency response and lowest latency. *SD Slow* causes a small drop in the higher frequency range. *Sharp* and *Slow* equal SD Sharp and SD Slow, with higher latency but linear phase over the whole audio band. *NOS* has the smallest steepness and therefore affects treble more than the others, but offers the best impulse response. See the Technical Reference section for graphs illustrating the results in frequency response and impulse response.

Notes for AKM units: NOS deactivates the option De-Emphasis. At sample rates higher than 192 kHz the DA Filter selection is no longer available. The DAC then uses a fixed Slow filter.

### De-Emphasis

Auto, OFF, ON. Default: Auto. For manually de-/activating the DAC's de-emphasis filter. See chapter 31.1.

---

## Dual EQ

OFF or ON. Default: OFF. When set to ON, the 5-band parametric equalizer can be set individually for left and right channel.

## Volume

Mirrors the direct volume control via Volume knob or encoder 1. The output level can be set between -96 dB and +6 dB, mostly in steps of 0.5 dB. The encoders use a special accelerator algorithm. Fast turning increases the step size. At moderate turning speed the changes in dB cause the expected volume change. Only at slower turning the finest steps will be used.

## Lock Volume

Deactivates volume control via the big VOLUME knob. Volume within the menu still works, and is used to set the desired output level. Active Lock is indicated in the VOL and Volume screen and the status bar.

## Balance

Mirrors the balance control in the VOL screen. Adjustable from L 100 (left) through <C> (center) to R100 (right). A quick turn jumps from L or R to <C> and vice versa.

## Mute

Mutes the current output. Can also be controlled via the VOL screen, a push on the Volume knob, and *Remap Function Keys*. Adjusting Volume to a higher value immediately disables mute, lowering Volume takes over the volume value without disabling mute.

## Dim

Reduces the volume of the current output by 20 dB. Also available via the *Remap Function Keys*. Adjusting Volume to a higher value deactivates Dim immediately, lowering Volume will set the Dim value as new Volume value.

## Loopback to USB

Off, pre FX, post FX. Switches the playback signal to the digital recording path. Mainly useful for Mac users who can then view the playback data in *DIGICheck*. Windows users can use this option to view not only the original playback data, but now also the DSP modified playback data in *DIGICheck* or other ASIO programs.

## 12.2 Subpage Parametric EQ

### EQ Enable

ON, OFF. Default: OFF.

### Band 1 Type

Available settings are Peak, Shelf, High Cut and High Pass (Low Cut). All filters are adjustable from 20 Hz to 20 kHz, at a Q of 0.5 to 9.9. Cut/Pass have a fixed 12 dB/oct filter steepness.

### Band 2-4 Type

Not available, fixed to Peak.

### Band 5 Type

Available settings are Peak, Shelf or High Cut. High Cut is adjustable from 200 Hz to 20 kHz, at a Q of 0.5 to 5.0 and a fixed 12 dB/oct steepness.

### Band 1-5 Gain

Available settings are -12 to +12 dB in steps of 0.5 dB.

### Band 1-5 Frequency

Adjustable from 20 Hz (200 Hz bands 4/5) to 20.0 kHz, in steps between 1 Hz and 100 Hz.

Line Out ①	
Parametric EQ ②	
EQ Enable	ON ▾
Band 1 Type	Shelf
Band 1 Gain	0.0 dB
VOL -5.0 dB SP c 48.0	

### Band 1-5 Q

Quality factor is adjustable from 0.5 to 9.9 in bands 1 to 3, and 0.5 to 5.0 in bands 4 and 5, in steps of 0.1 dB. This equals a bandwidth setting of 2.54 (0.5), 0.29 (5.0) and 0.146 (9.9).

**Subpage *Parametric EQ R* is only shown with Dual EQ set to On.** It has the exact same entries as listed above.

## 12.3 Subpage Bass / Treble

### B/T Enable

OFF, ON. Default: ON

### Bass Gain

Current Bass amplification for the current channels as set by encoder 1 (B). Adjustable between -6 dB and +6 dB in steps of 0.5 dB.

### Bass Freq

Corner frequency of the shelf bass filter. Adjustable from 20 Hz to 150 Hz in steps of 1 Hz. Default: 85 Hz.

### Bass Q

The quality factor of the filter is adjustable from 0.5 to 1.5. Default 0.9.

### Treble Gain

Current Treble amplification for the current channels as set by encoder 2 (T). Adjustable between -6 dB and +6 dB in steps of 0.5 dB.

### Treble Freq

Corner frequency of the shelf treble filter. Adjustable from 3 kHz to 10 kHz in steps of 100 Hz. Default: 6.5 kHz.

### Treble Q

The quality factor of the filter is adjustable from 0.5 to 1.5. Default 0.7.

Line Out ①	
Bass/Treble ②	
B/T Enable	ON ▾
Bass Gain	0.0 dB
Bass Freq	100 Hz
VOL -5.0 dB SP c 48.0	

## 12.4 Subpage Loudness

### Enable

ON, OFF. Default: OFF.

### Bass Gain

Maximum Bass amplification. Adjustable between +1 dB and +10 dB in steps of 0.5 dB. Default: +7 dB

### Treble Gain

Maximum Treble amplification. Adjustable between +1 dB and +10 dB in steps of 0.5 dB. Default: +7 dB

### Low Vol Ref

Reference level for highest Bass/Treble amplification, referenced to the Volume set in dB. Available range is -90 dB to -20 dB. Default: -30 dB. A volume setting below this point will have maximum Bass/Treble gain, all volume settings above this point will have lower Bass/Treble gain. 20 dB above the Low Vol Ref setting the Bass/Treble gain will be zero.

Line Out ①	
Loudness	
Bass Gain	7.0 dB
Treble Gain	7.0 dB ▲
Low Vol Ref	-30.0 dB ②
VOL -5.0 dB SP c 48.0	

Note that changing the Ref Level will need a manual update of the Low Vol value. Loudness is therefore most efficient in Auto Ref Level mode.

## 13. EQ

The key EQ brings up a graphical EQ display (Bode plot) screen to set the EQ quickly and with full overview for the current output. The *I/O - Settings* submenu *Parametric EQ* mirrors the settings done in this screen.

Turning encoder 2 or pushing VOLUME repeatedly scrolls through all 5 bands, as can be seen in the parameter line (B1 to B5). VOLUME steers the **gain** of the current band, the other parameters are not available for adjustment. This view provides quick view and verification of all parameters of all bands, without the risk of changing any of them unintentionally.

Push encoder 2 to select the **parameter line**, with all values now shown in white color. They can be adjusted by turning the three encoders. The Volume knob changes Gain, encoder 1 Frequency, encoder 2 Q (Quality factor). All changes are shown in real-time as frequency response curve (Bode plot), making it very easy to find the desired settings.

The five bands have different colors to clearly show what is currently selected: band 1 red, band 2 yellow, band 3 green, band 4 light blue, band 5 dark blue. To change to the next band push VOLUME.

Another push on encoder 2 selects the **filter symbol** in the right of the parameter line. As this function is only available in bands 1 and 5, the symbol stays greyed out in band 2, 3 and 4. Band 1 and 5 can be set to work in Peak mode, Shelf mode or as High Pass / High Cut. Turning encoder 2 scrolls through the available options with the symbol changing according to the selected filter function.

The next push on encoder 2 changes to the **graphical EQ Preset selection**. Turning encoder 2 will scroll through all EQ presets while the display shows the respective Bode plot and the name of the preset in the parameter line. In this screen VOLUME is available to change the volume and to switch the current output.

Pushing encode 2 again returns to the above band gain control. From here it is possible to directly jump to the graphical EQ selection by pressing encoder 1 one time.

If the frequency graph is shown as **grey line** the EQ is disabled. There are two ways to change this state:

- Push key EQ again to change to the page EQ Enable / Presets, see below.
- Push key I/O, select current output, subpage Parametric EQ, EQ Enable ON or OFF

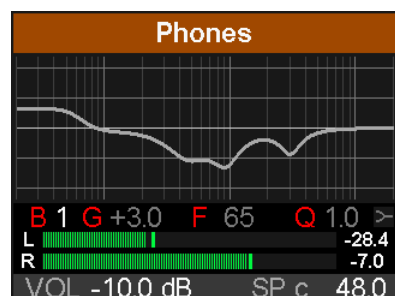
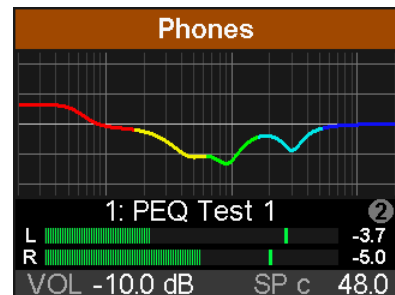
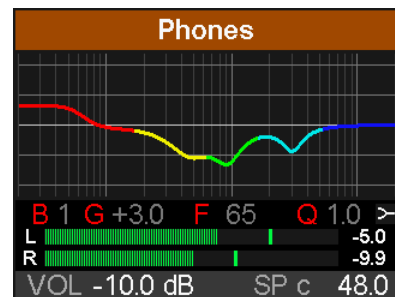
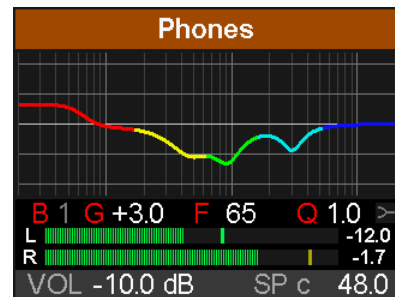
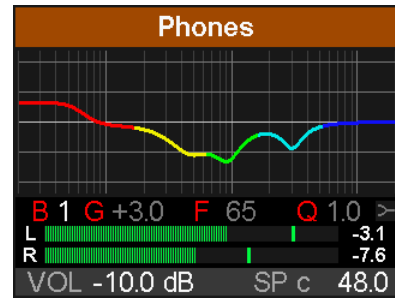



## Notes

The frequency graphics give a precise overview of the filter results. Overlapping filters influence each other. This can be used to achieve more than 12 dB gain, or to generate difficult frequency response optimizations.

The ADI-2 DAC has an internal headroom of 24 dB. Extreme boosts with overlapping filters could cause an internal overload. Such an overload will be visible as it is displayed by the level meter below the EQ, as well as the channel's level meter. Reducing the output volume will prevent any clipping as long as the headroom of 24 dB is not exceeded. In real-world operation that is always the case, the ADI-2 DAC will not distort internally.

Pushing the EQ key a second time brings up the **EQ Enable / Presets** screen. In this screen the EQ can be switched on and off, and EQ presets can be stored and loaded comfortably.

## EQ Enable

Default: OFF. Options are ON, OFF, L, R (L and R are only available with Dual EQ activated).

## Preset Select

Load or store up to 20 different EQ settings. The first choice, Manual, holds the current, unsaved EQ settings. The second choice, Temp, holds the settings of a loaded and then modified Preset. This scheme lets the user easily change and compare three different EQ settings: the manual one, the 20 stored presets and the modified preset, without losing changes while listening to a different set of EQ settings.

The last entry (21, Clear) corresponds to the factory default with all bands at 0 dB. It is not available to store a preset, but is used for resetting one by overwriting. A preset reset in this way, resulting in an 'empty' preset, is marked with **(lin)**.

The presets are independent from and not stored with Setups (see chapter 14.2). EQ Presets are therefore always available, no matter which Setup has been loaded. The Setup does include the current EQ setting, which on load is written into the memory slot Manual.

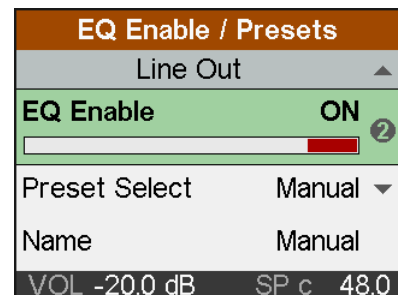

## Name

Allows to edit the name of the current preset and to edit the name during the store process. Turn encoder 2 to select a letter, number or symbol, then press encoder 2 briefly to enter the next sign. After the last sign the cursor jumps to the field *Store to*. The name can consist of up to 14 signs. Turning encoder 1 gives access to all existing preset names, so copying and modifying a preset can be done more quickly.

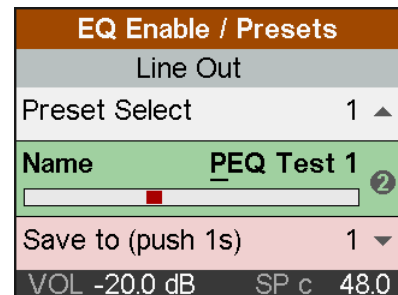

Changing the name is always stored immediately during editing, without further confirmation.

Leaving this field the name is automatically adjusted to the right. Adding signs to the front and rear is possible afterwards. A quick turn to the left brings up space, which is also used to quickly delete letters. Available signs are:

Space, Aa to Zz, + - / ( ) \* ; : . , ! # \$ & < > = ' | @ , 0 - 9

## Save to

Use encoder 2 to select the slot where the current preset should be stored to. To store press and hold encoder 2 for one second.

---

## 14. SETUP

The key Setup gives access to two top level screens: *Options* and *Load/Store all Settings*. *Options* has the subpages *Remap Keys / Diagnosis*, *Phones / DSD*, *Clock* and *Display*.

### 14.1 Options

#### 14.1.1 Remap Keys / Diagnosis

Subpage *Remap Keys /Diagnosis*, has the following entries:

##### Remap Keys

OFF, ON, Remote. Default: Remote. Allows to assign 32 different functions/actions to the four function keys on the unit and on the remote, or the remote only. Configuration is done via the following four entries:

**VOL (1), I/O (2), EQ (3), SETUP (4)**. Available functions/actions:

Setup 1 to 9, Mono, Mono to L, Mute, Loudness, EQ enable, B/T enable, EQ+B/T+Ld, Toggle Ph/Line, Polarity, AutoDark, Dim, Toggle View, Crossfeed 1 to 5, DA SD Sharp, DA SD Slow, DA Sharp, DA Slow, DA NOS, DA SD LD.

The original function of the key, entering the menu, is still available by pushing the key at the unit for half a second.

##### Notes on Remap Keys:

Factory default for remote buttons 1 to 4:

1: Mono, 2: Loudness, 3: AutoDark, 4: Dim

##### Test Results

Please ignore. For internal use only.

##### SW Version

Shows the current version number and date of the DSP firmware.

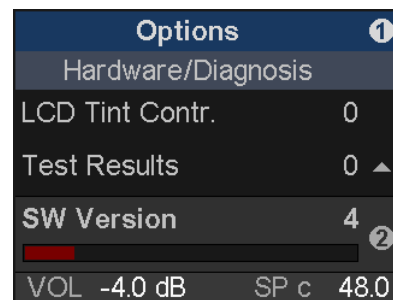

## 14.1.2 Clock

The subpage *Clock* has the following entries:

### Clock Source

Shows the current clock source INT (internal), optical or SPDIF coaxial. The clock source is automatically determined and set by the unit, a selection is neither possible nor necessary. With USB the internal clock is used, with SPDIF the external one.

### Sample Rate

The sample rate is also automatically determined and set by the unit. With USB the current sample rate of record/playback is set (INT), with SPDIF the sample rate of the SPDIF signal (Optical/SPDIF c).

Options ①	
Clock ▲	
Clock Source	SPDIF c ②
Sample Rate	48k ▼
DSD Rate	no DSD
VOL -16.0 dBr SP c 48.0	

ADAT input signal: The automatic clock control requires the ADAT data stream to include SMUX2 indication, in case of 88.2 and 96 kHz sample rate. As there is no indication for 176.4 and 192 kHz (SMUX4), these sample rates are not supported with ADAT.

The unit's internal clock supports 44.1, 48, 88.2, 96, 176.4, 192, 352.8, 384, 705.6 and 768 kHz. Sample rates 44.1 to 192 kHz are also supported for the SPDIF input. In the lowest line the **DSD rate** equalling the current sample rate is shown.

## 14.1.3 Phones / DSD

The subpage *Phones / DSD* has the following entries:

### Mute Line

OFF, vs. Phones, Toggle Ph/Line. Toggle Plugged. The default, vs. *Phones*, activates mute of Line Outs when inserting a phones or IEM plug. Alternatively *Toggle* activates the ability to manually switch between 'front' and 'rear'. It allows to have the Phones/IEM connected all the time. To change push the VOLUME knob for half a second. Via *Remap Function Keys* this function can also be controlled by one of the four function keys or the remote control. *Toggle Plugged* additionally activates the switching between Phones and IEM, automatically detected by the sensor contacts of the two outputs. Which also works via Remote and Function Keys, if *Toggle Ph/Line* has been activated there.

### DSD Direct (Line) – not available on ESS units

OFF, ON. Default: OFF. When activated a DSD playback will use DSD Direct mode over the rear outputs 1/2. As DSD Direct bypasses all DSP calculations and volume control, the only way to change the output volume is by setting different reference levels. Therefore in DSD Direct mode outputs Phones and IEM are disabled.

### DSD Filter

When DSD Direct mode is active, high-frequency noise filters help to reduce such noise, which is quite high in level and might have negative impact on other equipment. While 50 kHz is optimized for DSD64 and 70 kHz for DSD 128 and 256, the user can freely try both at any DSD rate.

### DSD Detection

Default: ON. Option to deactivate the automatic DSD detection on SPDIF and USB.

Options ①	
Device Mode ▲	
Mute Line	OFF ②
DSD Direct (Line)	OFF ▼
DSD Filter	50 kHz
VOL -20.0 dB SP c 44.1	

---

### 14.1.4 Display

The subpage *Display* has the following entries:

#### **Display Mode**

Available settings are: Default, Dark. The dark scheme inverts the white background and black numbers/text to black background and light-grey numbers/text in all menus.

#### **Meter Color**

Green, Cyan, Amber. Default: Green. Sets the meter screen colour in PCM and DSD mode.

#### **Hor. Meter**

The horizontal stereo level meter below the Analyzer can show the peak level before all DSP processing (**Pre**, equals the current input level from USB playback and SPDIF In), after all processing including volume control (**Post**), or both at the same time (**Dual**). The outer thin line is the Pre level. In Dual mode the peak values to the right refer to Post level.

#### **AutoDark Mode**

OFF, ON. Default: OFF. Automatically turns off all LEDs and the display after 10 seconds of user inactivity. A key press, turning an encoder, warning messages and the remote control will temporarily activate LEDs and display again. Using the remote the time for entering dark mode is 3 seconds.

#### **Show Vol. Screen**

ON, OFF. Default: ON. When turning the VOLUME knob the Volume screen is shown.

#### **LCD Brightness**

Adjustable from 20% to 100%. Default is 80%.

#### **LCD Tint Control**

Adjustable from -8 (yellow) to 8 (blue). Enables compensation of the display's colour deviation as well as suiting the user's taste.

### 14.1.5 Expert Settings

This menu only exists for ADI-2 DACs with an ESS DAC chip. It provides access to specific configuration parameters of the chip, such as THD compensation and fine adjustment of the output level. It is mainly intended for engineers and technicians.

All settings are automatically stored in the device and automatically loaded when the menu is activated.

#### **Enable Settings**

OFF, ON. Default: OFF. When activated, the other setting options are displayed. OFF activates the factory settings.

#### **THD Comp K2L (K2R, K3L, K3R)**

The ESS allows the adjustment of a correction factor to reduce the second and third harmonic, i.e. a reduction of the harmonic distortion. The THD Compensation is adjustable in wide ranges, where 0 corresponds to the RME factory setting.

Very high values (10.0k) cause around -60 dB distortion (0.1%). It is therefore also possible to use K2 and K3 separately and intentionally as an effect. This can be quite instructive - when one notices that no difference between 0.1% and 0.0001% distortion is audible.

#### **Gain Tune L, R**

Used to calibrate the output level in the range 0 to -0.5 dB, in steps of 0.01 dB.

---

## 14.2 Load/Store all Settings

This option allows to save the whole state of the unit as Setup in up to 9 different memory slots. The EQ Presets are not included, they are stored separately and are available for any setup.

The current state of the EQ is also stored. During load of a Setup the EQ is written to the memory slot *Manual*.

The page *Setups, Load/Store all Settings*, has the following entries:

### Setup Select

Choices are Load 1-9, Factory (Reset All) and Store 1-9.

### Name

Allows to edit the name of the Setup during the store process. To edit an existing name load the respective Setup and store it on the same memory slot with edited name. See *EQ - Name* for details about the Edit operation.

### Start

Press 1s. Pressing and holding encoder 2 for at least one second triggers the action selected (Load or Store).

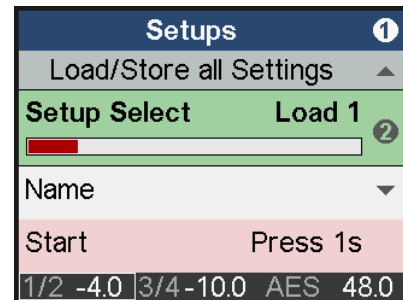

### Returning to Factory State

Is described in chapter 7, page 11.

## 15. Top Screens

The ADI-2 DAC has four different top screens: an *Analyzer* showing the audio signal content of the analog outputs, a *State Overview* showing the digital states of SPDIF and USB, a *Dark Volume* screen with some additional information, and *Dark Volume Details*, showing all currently active DSP functions.

Pushing the small encoder 1 or 2 cycles through them if any is currently active. To quickly call them up simply press any of the four function keys one or two times. The remote can be used for this as well after, assigning the command *Toggle View* to one of the four programmable buttons (see chapter 14.1.1, Remap Keys).

### 15.1 Dark Volume / Details

This screen has been added as alternative to the other meter screens, which even with the dark theme selected might be disturbing in some situations. *Dark Volume* shows the current volume setting, the current reference level setting, the amount of Bass/Treble gain applied and the currently used input or source. It is low in brightness, still fully readable in bright environments, and has zero flickering or moving elements (level meters). Volume and Bass/Treble adjustments happen right in this screen, which makes its functionality not only visually pleasing.



Despite this screen having no level meters, overloads caused by Volume, PEQ or Bass/Treble are easy to recognize. The big volume number is coupled to the over detection of the analog outputs. It changes its color to red when overloads occur.

As with the other top screens, once selected it becomes the default screen, automatically shown after power-up or when leaving a menu.

---

The *Dark Volume Details* screen displays some more information, like the currently used EQ Preset, and any active DSP FX.

## 15.2 Analyzer

The Analyzer is based on RME's famous Spectral Analyzer in DIGICheck. It uses 29 biquad bandpass filters for high separation between the bands, providing outstanding musical visualization. Using carefully selected attack and release times the display is responsive, but still easy to read. On top it uses RME's own *Max LR* technique to prevent 6 dB higher level display for monoaural signals, and zero display with out-of-phase signals.

Thanks to the high-resolution IPS panel even smallest details are clear to see. Music content analysis is possible even when viewed from a greater distance.

The Analyzer operates at any sample rate, and even with DSD. There are no parameters to change, and the shown frequency range is always the human audible range, 20 Hz up to 20 kHz.

To be able to also show DC content the lowest band is not a band-pass filter, but a low pass, catching the whole range from 0 Hz up to 30 Hz. With some unusual signals it therefore can happen that the level shown will be a bit higher than expected.

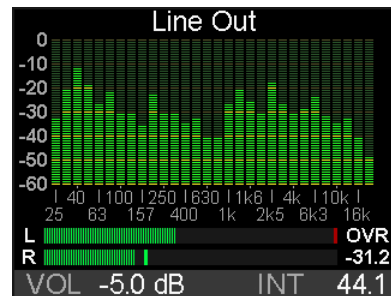

As opposed to most other solutions no FFT (Fast Fourier Transform) is used. RME's Spectral Analyzer performs a true band-pass filter calculation, as in professional hardware devices. The frequency distance between the filters is scaled matching human hearing. The highly optimized code allows to run a 30 band analyzer with 60 dB range, sharp filters and 0.5 dB steps accuracy per band, on the ADI-2 DAC DSP, even at 768 kHz sample rate.

The most important application using a Spectral Analyzer is the visualization of frequencies and levels found in music or speech. The Analyzer shows levels and frequencies even at the edge of the human ear's abilities – or that of the used speakers and headphone. The visual display helps to train ones ears, makes coarse errors visible, and shows what sometimes might stay unnoticed. For example many speakers won't let you hear frequencies below 30 Hz. Simply look on the Analyzer to see what's going on in the underground.

The vertical level meters (also in the EQ screen) are peak level meters with peak hold function, band limited to 40 kHz even at higher sample rates. OVR (Over) are displayed in red color at the upper end. For the digital inputs (Pre-FX), Over appears when the signal is at the maximum possible level. As usual in digital audio, Over is then already displayed even if there is no real overload.

OVR appears for the rear XLR, RCA and front IEM outputs (Post-FX) at +2.5 dBFS, since the ADI-2 DAC has this digital headroom. For the Phones output, OVR appears from +1 dBFS, since the analog circuitry limits the headroom here. The current peak hold value is displayed numerically to the right. Levels below -119 dB appear as UFL (Underflow).

---

## 15.3 State Overview

The State Overview screen is a typical RME feature. Since 20 years we prefer to give our customers more information at hand than just 'something there'. The Settings dialogs of our audio interfaces include detailed Input Status analysis to simplify setup and ease trouble-shooting. Additionally RME provides a free tool with any audio interface, DIGICheck, which analyzes levels, Channel Status and bit stream content, the true hardware sample rate and much more.

When the ADI-2 DAC is connected but no sound can be heard then RME's analysis tools come to the rescue. The *State Overview* screen is there to track down the problem in an easy to understand and efficient way. Although it might look simple (fully intentional!), it includes detailed analysis that outperforms any other similar device.

Shown are the current states of the digital inputs SPDIF optical and coaxial, and USB connection with the audio transmitted. The current Clock source is mentioned in full length, although this information is also found abbreviated in the status bar at the bottom.

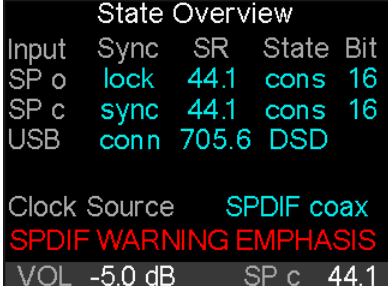

State Overview				
Input	Sync	SR	State	Bit
SP o	lock	44.1	cons	16
SP c	sync	44.1	cons	16
USB	conn	705.6	DSD	

Clock Source	SPDIF coax
SPDIF WARNING EMPHASIS	
VOL -5.0 dB	SP c 44.1

The status bar always shows the current volume setting, the current clock source, and the current sample rate. In case of Sync problems the sample rate will either fluctuate or be shown in red – or both. This information is available in nearly all screens, and helps to get a quick overview of the current state. The State Overview screen now extends this information in great detail.

The SPDIF inputs are shown as **SP op** and **SP co** (optical / coaxial). The SYNC column shows No Lock, which equals no signal present, as - -. And **lock** and **sync**, according to the current clock state of the respective input.

In case of USB **conn** (connected) is shown as soon as a valid USB connection is established.

The column SR shows the hardware measured sample rate for the SPDIF input. It will even display values that can not be set at the ADI-2 DAC itself, for example 32, 64 and 128 kHz. In case of USB the sample rate is not measured but set by the external computer or iOS device, and can be verified here, up to the highest value of **768** kHz.

The State column shows the Channel Status, Consumer (**cons**) or Professional (**pro**), for incoming SPDIF (AES) signals. In case a DoP (DSD over PCM) header is detected **DSD** is shown. With USB the state column shows the current channel mode, **2/2**, or **DSD** if a DoP header is detected.

The Bit column shows the amount of bits found in the SPDIF audio signal. Note that a 24 bit signal that is shown as 16 bit is indeed 16 bit, but a signal shown as 24 bit might contain only 16 bit real audio plus 8 bits of noise...

But SPDIF can also transport AC-3 and DTS encoded surround sound. This signal sounds like chopped noise at full volume. Therefore the ADI-2 DAC receiver circuit checks the Non-Audio flag within the Channel Status. If found the signal is already muted directly in the receiver. An error message is shown in red colour in the lowest line, saying SPDIF NON-AUDIO, explaining why there is no sound at the analog outputs despite a valid input signal.

Finally also Emphasis, a special treble boosting equalization method from the early days of digital audio, is detected and shown as SPDIF WARNING EMPHASIS. See chapter 31.1.

---

## 16. Warning Messages

The ADI-2 DAC will show different warning messages and provide guidance in certain cases.

### Hi-Power Mode Active (Phones)

When Hi-Power mode is active with the Volume set higher than -15 dB and a phone is plugged in, this message reminds the user to check the current volume setting, and to make sure the used headphone will stand the high output power without getting destroyed. The audio signal is held at a low volume until the gain is set to -15 dB or below. The Volume knob is active on the current phones output and can be used to turn down the volume. Once -15 dB is reached the volume is ramped up to the current gain.



**Hi-Power Mode Active**  
Reduce Volume and make sure your headphones can handle Hi-Power mode.  
Press Encoder 1 to continue

Pressing encoder 1 removes the message immediately, with volume ramped up within 2 seconds to the set value. The message will also vanish when the phone is unplugged again.

This message is not shown when Volume is set to -15 dB or lower, or when the device is switched on while the phones are already connected.

### Overload / Short detected (Phones)

An internal overload can be caused by too high output levels and too low load impedance. A short circuit in the TRS plug will also trigger the overload detection. In such a case the relay will permanently disconnect the phone from the Extreme Power output stage. If the phones plug is removed and plugged in again after one second, the unit will activate the phones output again.



**Overload / Short detected**  
Phones deactivated.  
Pull out Phones plug to reset output state.

This scheme has been introduced to force the user to check cabling and connection. For example, a TRS plug not fully inserted might stay unnoticed but can cause a short circuit.

### DC detected (Phones)

DC detection is crucial to prevent the sensitive phones drivers from being destroyed by inaudible currents flowing through them. As the ADI-2 DAC is fully DC coupled from DAC to phones output, a digital full scale signal with 0 Hz would produce up to 15V DC at the outputs, and destroy any attached phone immediately. In case the power output stage fails the same could happen. Therefore the phones outputs will switch off with 1.8V DC detected.



**DC detected**  
Phones deactivated.  
Pull out Phones plug to reset output state.

### Power Fail

In case the operating voltage drops below 9.3V the internal power supply of the analog I/Os is switched off (overcurrent protection). However, the digital part will operate even with only 5V. Therefore connecting a wrong power supply could pretend a fully working unit - which doesn't receive or emit any audio. This warning informs about the undervoltage problem.



**Power Fail**  
Analog I/Os disabled.  
Check DC power supply.

### Internal Error

During power-on the unit performs a self-test. When this test fails USB will be deactivated, with record and playback no longer functional. In such a case please contact your local RME distributor.



**Internal Error**  
USB Audio disabled.

The ADI-2 DAC also shows **Info Messages** during normal operation, to explain the current state and to point out possible problems.



---

At input SPDIF, a Non-Audio Channel Status causes the DA section to be muted. An info message *Non-Audio signal at SPDIF input* gives a hint why there is currently no analog audio at the outputs present.

In USB mode, an Emphasis Channel Status brings up the info message *Emphasis detected at SPDIF input*. This reminds the user that the Emphasis indication gets lost when recording through a computer.

## 17. DSD

### 17.1 General

DSD (Direct Stream Digital) is a stream with single bit resolution, but multiple times the sample rate of the CD. DSD64 equals 64 times 44.1 kHz = 2.8 MHz, DSD128 5.6 MHz, DSD256 11.2 MHz. Versions with multiples of 48 kHz also exist, up to 12.2 MHz.

To transfer DSD data over SPDIF, AES or even USB, *DSD over PCM* (DoP) is the de-facto standard. It uses only the lower 16 bit of a 24 bit word, the upper 8 bit are filled with a DoP header signal to be able to detect it, and to lower the overall volume to prevent damage in case of accidental playback as PCM data. Note that the data stays pure DSD and is NOT converted to PCM.

The ADI-2 DAC supports DSD in various ways. When received via SPDIF, the State Overview screen will show **ISPDoP**, and the DAC immediately turns from PCM to DSD mode. The process is transparent to the user, playback will continue as usual. But there are no DSP functions possible on a bit stream. Therefore EQ, Crossfeed, Bass/Treble, Loudness and other audio functions provided by the DSP are deactivated. This is shown by adding brackets to the activated function, for example EQ Enable - (ON).

The DoP recognition also works on USB. A DSD playback via USB (State Overview shows **DSD**) will be done at 176.4/192 kHz for DSD64, 352.8/384 kHz for DSD128, and 705.6/768 kHz for DSD256. Under Windows WDM/WASAPI are currently limited to 384 kHz. The highest sample rates and DSD modes can only be used via ASIO. RME's driver supports DSD over ASIO in DoP format as well as ASIO native. ADI-2 DAC therefore is compatible to many programs, like HQPlayer, and JRiver, but also to DSD recording software like Merging's Pyramix, Sound-It and VinylStudio.

### 17.2 DSD Direct

To be able to digitally adjust the volume, DSD data must be converted to PCM. This is done automatically within the DA converter chips. In DSD Direct mode there is no PCM conversion – and consequently no volume control anymore. After having activated DSD Direct in the ADI-2 DAC's menu (SETUP - Options - Phones / DSD - DSD Direct (Line)), the analog signal is available only at the rear outputs, with a coarse volume control via the analog output reference level control. Outputs Phones and IEM are deactivated.

In DSD Direct mode the output level for digital full scale is 1.0 dB lower than with standard DSD mode. Therefore the maximum analog output level is 1.0 dB lower than the chosen reference level. For a valid comparison between DSD and DSD Direct the volume of DSD should be set to -1.0 dB.

#### Units with ESS chip

These chips do not support DSD Direct. Instead word is that the included, extensive volume control was designed so that it can even process DSD data without PCM conversion. Unfortunately official information on this topic is either vague or non-existent.

## 17.3 DSD Playback

While most DACs, even ones seen as 'Hi-End', leave the user clueless during DSD operation, the ADI-2 DAC continues to show level as well as spectral content. To be able to show the analog I/Os audio signals on level meters and Analyzer the DSP performs an additional DSD to PCM conversion.

Analyzer and level meter show DSD signals in blue colour for Green and Cyan, the current mode is therefore easy to recognize (Amber gets a bit lighter).

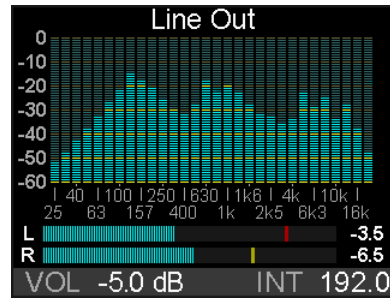

During a DSD playback all DSP functions of all channels are temporarily disabled, even when transmitting PCM. This is signalled in several menus by brackets around the (ON) and greyed-out menu entries. An exception is the function *Polarity*, which stays available for one and both channels.

**Note:** The change between PCM and DSD causes a low volume click noise. For optimized sound and fidelity, the ADI-2 DAC does not use any lossy analog volume control, hence can't suppress the DAC's low level click noise.

You may notice clicks and cracks at the title change quite often with DSD, even when the next title has the exact same sample rate. This is caused by the 1-bit format, which, unlike PCM, requires absolute silence and DC freedom at the beginning and end of a title, so that the transition as required by the 1-bit stream does not represent a random signal, which can sound like a click or crack. Unfortunately, many freely available tracks are not 'clean' at the beginning and the end. If these are played back one after the other by player software, the ADI-2 DAC's level meters show that the noise to be heard does not originate from the ADI-2 DAC, but is presented to the DAC as a signal to be played. The level meters are in the digital domain before the DAC, so proof of a faulty input signal is easy.

## 17.4 DSD Record

Via USB the SPDIF inputs can record not only PCM but also DSD (DoP).

The source options and block diagram in chapter 31.15 are valid for DSD operation as well, with both record and playback. The only difference: with DSD the circuit part *DSP* is bypassed (no audio processing). In DSD mode all DSP functions are temporarily disabled. This is signalled in several menus by brackets around the (ON).

Software to record DSD audio:

Name	OS	URL
VinylStudio	Win/Mac	<a href="http://www.alpinesoft.co.uk">www.alpinesoft.co.uk</a>
Sound-It!	Win/Mac	<a href="http://www.ssw.co.jp">http://www.ssw.co.jp</a>
Pyramix	Win	<a href="http://www.merging.com">www.merging.com</a>
AudioGate4	Win/Mac	<a href="http://www.korg.com">www.korg.com</a>

---

## User's Guide



# ADI-2 DAC

## ► Inputs and Outputs

---

## 18. Digital Inputs

Two SPDIF inputs are available, optical via TOSLINK and coaxial via RCA, but only one can be used at a time. The currently used SPDIF input can be chosen under *I/O - Settings – Source*. Set to Auto the input with a valid input signal will be chosen automatically.

The optical input also understands ADAT format, up to 192 kHz, but only channels 1/2 of the 8-channel signal are available.

Using a simple cable adapter XLR to RCA, an AES/EBU signal can be received too. To achieve this, pins 2 and 3 of a female XLR plug are connected individually to the two pins of a phono plug. The cable shielding is only connected to pin 1 of the XLR - not to the phono plug.

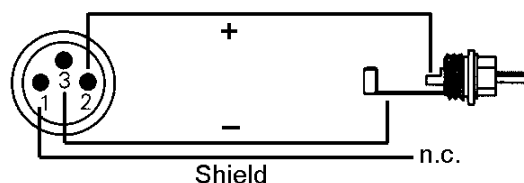

## 19. Analog Outputs

### 19.1 General

The rear RCA and XLR outputs and the front outputs Phones and IEM are fed from the same DAC, hence carry the same signal. They all have individual driver stages with different output levels, see next chapters for details.

All outputs feature mute components to suppress power on/off noise, even when power fails instead of switching the unit off via its standby button.

SNR and THD values as well as frequency response are nearly identical on all analog outputs.

Both phone outputs feature mute function, over-current detection, DC protection, plug detection and DSP control, like auto assigning volume, volume ramp up, user interaction at overload detection, and low impedance level meter auto scaling.

### 19.2 Line Out RCA

The ADI-2 DAC has two unbalanced analog outputs that can operate with levels up to +15.5 dBu (Ref Lev +13 dBu with Volume set to +2.5 dB). The short circuit protected, low impedance line outputs are available as RCA jacks on the back of the unit.

To maintain an optimum level for devices connected to the analog outputs and to maximize the dynamic range, the ADI-2 DAC internally uses hi-quality electronic switches, which realize a hardware based Reference Level selection in steps of 6 dB over a range of 18 dB: -5 dBu, +1 dBu, +7 dBu and +13 dBu.

Note: XLR provides a 6 dB higher output level in all settings, equalling +1 dBu up to +19 dBu. For **Auto Ref Level** see next chapter.

---

### 19.3 Line Out XLR

The ADI-2 DAC has two balanced analog outputs that can operate at levels up to +21.5 dBu (Ref Lev +19 dBu with Volume set to +2.5 dB). The short circuit protected, low impedance line outputs are available as XLR jacks on the back of the unit.

- ! **The XLR line outputs do not operate servo balanced!** When connecting unbalanced equipment, make sure pin 3 of the XLR output is not connected. A connection to ground might cause a decreased THD (higher distortion) and increased power consumption!

To maintain an optimum level for devices connected to the analog outputs and to maximize the dynamic range, the ADI-2 DAC internally uses hi-quality electronic switches, which realize a hardware based Reference Level selection in steps of 6 dB over a range of 18 dB: +1 dBu, +7 dBu, +13 dBu and +19 dBu.

The analog outputs also feature a mechanism to set the reference level automatically. **Auto Ref Lev(ell)** maximizes the signal to noise ratio when using the Volume knob. It changes to the next higher and lower reference level setting when the gain chosen via the Volume knob would suggest to set a better fitting value, with optimized signal to noise ratio.

Example: Ref Lev is set to +19 dBu, Volume is turned down to -20 dB. The effective signal to noise ratio at the XLR output is now 120 dB minus 20 dB = 100 dB (RMS unweighted). While it is unlikely that any noise will be audible, changing the Ref Level to +1 dBu would need only a Volume setting of -2 dB to achieve the same level or volume. The effective SNR then becomes 117 minus 2 = 115 dB (15 dB higher). Such settings are usually done manually by the user. Auto Ref Lev takes over this task, working in both directions when turning Volume up or down.

#### Notes on Auto Ref Level:

This technique includes switching of hardware elements (like when doing it manually) and is therefore not free of click noise. To prevent distortion the threshold for a Ref Level change takes EQ gains into account. Auto Ref on the Phones output will be inactive when Line Out and Phones out are set to work simultaneously, and Auto Ref is enabled on the Line out.

### 19.4 Phones Out

The stereo phones output is available on the front as 1/4" TRS (stereo) jack.

Phones has two hardware reference levels: *Low Power* which equals +7 dBu (1.73 V), and *High Power* with +22 dBu (10 V).

*SETUP – Options – Phones / DSD – Mute Line* offers an option to turn off the rear outputs as soon as a phone is plugged in. Default is *vs. Phones*, which means Line muted when plugged.

In case the output should operate as line output, an adapter TRS plug to RCA phono plugs, or TRS plug to TS plugs is required.

The pin assignment follows international standards. The left channel is connected to the tip, the right channel to the ring of the TRS jack/plug.

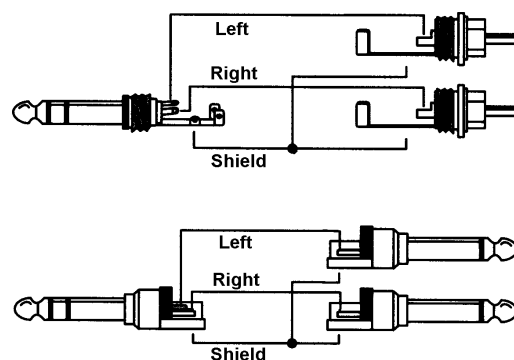

---

## 19.5 IEM Out

This output via stereo mini-TRS is optimized for the use of high-quality IEMs, but generally works very well with portable headphones that do not require high power or voltage. The IEM output might be the world's lowest-noise headphone output at an output impedance of less than 0.1 Ohm, and without resorting to tricks such as a voltage divider with resistors at the output.

Maximum output level is -0.5 dBu (with Volume set to +2.5 dB), equalling 0.73 Vrms. The noise floor at extremely low -124 dBu(A) stays inaudible even with the most sensitive In-Ears. At full output level and loaded with 16 Ohms, distortion is lower than -110 dB or 0.00039 %.

*SETUP – Options – Phones / DSD – Mute Line* offers an option to turn off the rear outputs as soon as a phone is plugged in. Default is *vs. Phones*, which means Mute when plugged.

Due to the very low output voltage and output power the IEM output does not need DC protection, overload and short circuit detection.

## 19.6 Using more than one Output

If *SETUP – Options – Phones / DSD – Mute Line* is set to OFF, all three outputs will work simultaneously. The Line out specifies all settings. Its EQ, Bass / Treble, Loudness etc can be heard on Phones and IEM output. Since the device only has one DA converter, it naturally can not output three different digitally processed stereo signals.

The Line volume setting affects all at the same time as well. By manually selecting Hi- and Lo-Power on the Phones output, it can be brought to a suitable base level.

If Auto Ref Level is active on Line Out, there will be jumps in level when the Ref Level is exceeded or below on the Phones output. This is not a mistake - there are no hardware levels in steps of 6 dB on the phones out, so you can hear the volume changes of the DSP from the Line out without the Line Out Ref Level compensation. To avoid this do not use Auto Ref Level in such a multi-output application.

If Auto Ref Level is active on Line Out and Phones, the feature will be disabled on Phones. For a similar reason - otherwise there is a very unpleasant increase in volume of 15 dB on the Phones output when switching from Lo to Hi Power.

When using both headphone outputs, the output specifies the settings that will be used (plugged in) first. The device also remembers this when switched off and on again.

---

## User's Guide



# ADI-2 DAC

### ► Installation and Operation – Windows

---

## 20. Driver Installation

The ADI-2 DAC is fully compatible to Windows 10 (1709 or newer). The unit is automatically recognized when connected to the computer. WDM and WASAPI, from 44.1 to 384 kHz, and DSD playback via DoP (needs to be set in the respective player software) up until DSD256 will work directly, without any installed driver.

Installing the RME drivers adds ASIO (PCM, DSD DoP and DSD Native), and extends WDM up to 768 kHz. The drivers are also required for firmware updates and DIGICheck. **The following notes and chapters are based on installed RME drivers!**

RME is constantly improving the drivers. Please download the latest driver from the RME website at <http://rme.to/downloads>, driver\_madiface\_win\_09716.zip or newer. Unzip the downloaded file and start the driver installation by a double-click on *rmeinstaller.exe*. Follow the instructions of the installer. After installation connect computer and ADI-2 DAC. Windows detects the new hardware as **ADI-2 DAC** and installs the drivers automatically.

After a reboot, the icon of the Settings dialog appears in the notification area. Windows might hide it behind the triangle or upwards symbol. Click on it to access it and to configure its appearance.



Chapter 31.12 explains how to find the ideal USB port.

**Driver Updates** do not require to remove the existing driver. Simply install the new driver over the existing one.

Possible reasons why an ADI-2 DAC is not found automatically:

- The ADI-2 DAC is not switched on
- The USB port is not active in the system (check the Device Manager)
- The USB cable is not, or not correctly inserted into the socket
- Use the ADI-2 DAC State Overview screen to verify USB is detected and working (chapter 15.3)

### De-installing the Driver

Basically a de-installation of the driver files is not necessary. Thanks to full Plug & Play support, the driver files will not be loaded after the hardware has been removed.

Windows Plug & Play methods do not cover the registration of the ASIO driver. This entry can be removed from the registry by a software de-installation request. This request can be found (like all de-installation entries) in *Control Panel, Programs and Features*. Click on the entry 'RME MADiface', then *Uninstall*.

To use Windows own Class Compliant drivers the RME driver has to be removed completely (for example after a firmware update). In Device Manager select the ADI-2 Pro under *Sound, Video and Game Controllers*, right click and choose *Uninstall*. In the next dialog make sure to check 'Delete the driver software for this device'. Otherwise the driver will stay within the Windows installation and gets reinstalled automatically after the next reboot.

### Firmware Update

Please see chapter 7. Under Windows the flash update tool requires the MADiface series driver to be installed, see above.



---

## 21. Configuring the ADI-2 DAC

### 21.1 Settings Dialog

Configuration of the ADI-2 DAC is usually done directly at the unit. For ASIO operation sample rate and buffer size (latency) can be set via a dedicated settings dialog. The panel 'Settings' can be opened by clicking on the fire symbol in the Task Bar's notification area

Any changes made in the Settings dialog are applied immediately - confirmation (e.g. by clicking on OK or exiting the dialog) is not required.



However, settings should not be changed during playback or record if it can be avoided, as this can cause unwanted noises. Also, please note that even in 'Stop' mode, several programs keep the recording and playback devices active, which means that any new settings might not be applied immediately.

#### Buffer Size

The setting *Buffer Size* determines the latency between incoming and outgoing ASIO and WDM data, as well as affecting system stability.

**USB Diagnosis** shows specific USB transmission errors (CRC5/16, usually 0) and general errors. If the unit detects a record or playback error the number shown will no longer be 0. An audio reset is performed automatically. The counter is reset on start of playback/record.

#### Sample Rate

Sets the currently used sample rate. Offers a central and comfortable way of configuring the sample rate of all WDM devices to the same value, as since Vista the audio software is no longer allowed to set the sample rate. However, an ASIO program can still set the sample rate.

During record/playback the selection is greyed out, so no change is possible.

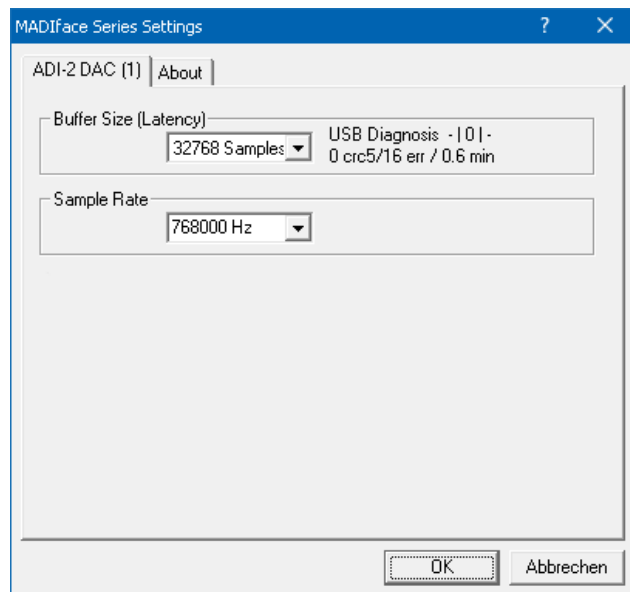

The tab **About** includes information about the current driver and firmware version plus two more options:

#### Lock Registry

Default: off. Checking this option brings up a dialog to enter a password. Changes in the Settings dialog are no longer written to the registry. As the settings are always loaded from the registry when starting the computer, this method provides an easy way to define an initial state for the ADI-2 DAC.

**Enable MMCSS for ASIO** activates support with higher priority for the ASIO driver. Note: At this time, activating this option seems to be useful only with the latest Cubase/Nuendo at higher load. With other software this option can decrease performance. The change becomes active after an ASIO reset. Therefore it is easy to quickly check which setting works better.

---

## 21.2 Clock Modes - Synchronization

In the digital world, all devices must be either Master (clock source) or Slave (clock receiver). Whenever several devices are linked within a system, there must always be a single master clock.

! *A digital system can only have one master! If the ADI-2 DAC's clock mode is set to 'Internal', all other devices must be set to 'Slave'.*

To cope with some situations which may arise in studio practice, defining a sync reference is essential. RME's exclusive **SyncCheck** technology enables an easy to use check and display of the current clock status. In the State Overview screen the column SYNC will show for all digital inputs whether there is a valid signal (Lock, No Lock) for the optical input, or if there is a valid and synchronous signal (Sync). See chapter 15.3.

Under WDM the ADI-2 DAC will (has to) set the sample rate. Therefore the error shown to the right can occur. An AES, SPDIF or ADAT signal with a sample rate of 48 kHz is used as sync source, but Windows audio had been set to 44100 Hz before. The red color of the text label signals the error condition, and prompts the user to set 48000 Hz manually as sample rate.



## 22. Operation and Usage

### 22.1 Playback

In the audio application being used, ADI-2 DAC must be selected as output device. It can often be found in the *Options*, *Preferences* or *Settings* menus, as *Playback Device*, *Audio Devices* etc.

Increasing the number and/or size of audio buffers in the application (WDM) or the RME Settings dialog (ASIO) may prevent the audio signal from breaking up, but also increases latency i.e. output is delayed.

Please note that currently Windows WDM is limited to 384 kHz. 768 kHz can only be used via ASIO.

Note: Since Vista the audio application can no longer control the sample rate under WDM. Therefore the driver of the ADI-2 DAC includes a way to set the sample rate globally for all WDM devices, found within the Settings dialog. See chapter 21.1.

### 22.2 Multi-client Operation

RME audio interfaces support multi-client operation. Several programs can be used at the same time. The formats ASIO and WDM can even be used on the same playback channels simultaneously. As WDM uses a real-time sample rate conversion (ASIO does not), all active ASIO software has to use the same sample rate.

Inputs can be used from an unlimited number of WDM and ASIO software at the same time, as the driver simply sends the data to all applications simultaneously.

RME's sophisticated tool *DIGICheck* operates like an ASIO host, using a special technique to access playback channels directly. Therefore DIGICheck is able to analyse and display playback data from any software, no matter which format it uses.

---

## 22.3 Multi-interface Operation

The current driver supports up to three RME devices of the MADiface series. All units have to be in sync, i.e. have to receive valid digital sync information. Under ASIO all devices are presented as one ASIO device with all available channels as I/Os.

If one of the units is set to clock mode Master, all others have to be set to clock mode Slave, and have to be synced from the master by feeding ADAT, AES or SPDIF. The clock modes of all units have to be set up correctly in their Settings dialog.

## 22.4 ASIO

Start the ASIO software and select **ASIO MADiface USB** as the audio I/O device or the audio driver.

The sample rate is set by the ASIO application. The buffer size (latency) is set in the RME Settings dialog.

The ASIO 2.2 driver supports sample rates up to 768 kHz in PCM format. DSD record/playback is supported as DoP within ASIO as well as via ASIO native. *ASIO Direct Monitoring* (ADM) is not supported.

## 23. DIGICheck Windows

The DIGICheck software is a unique utility developed for testing, measuring and analysing digital audio streams. Although this Windows software is fairly self-explanatory, it still includes a comprehensive online help. DIGICheck 5.93 operates as multi-client ASIO host, therefore can be used in parallel to any software, with both inputs and outputs (!). The following is a short summary of the currently available functions:

- **Level Meter.** High precision 24-bit resolution, 2 channels. Application examples: Peak level measurement, RMS level measurement, over-detection, phase correlation measurement, dynamic range and signal-to-noise ratios, RMS to peak difference (loudness), long term peak measurement, input check. Oversampling mode for levels higher than 0 dBFS. Supports visualization according to the K-System.
- **Spectral Analyser.** World wide unique 10-, 20- or 30-band display in analog bandpass filter technology. 192 kHz-capable!
- **Vector Audio Scope.** World wide unique Goniometer showing the typical afterglow of a oscilloscope-tube. Includes Correlation meter and level meter.
- **Totalyser.** Spectral Analyser, Level Meter and Vector Audio Scope in a single window.
- **Surround Audio Scope.** Professional Surround Level Meter with extended correlation analysis, ITU weighting and ITU summing meter.
- **ITU1770/EBU R128 Meter.** For standardized loudness measurements.
- **Bit Statistics & Noise.** Shows the true resolution of audio signals as well as errors and DC offset. Includes Signal to Noise measurement in dB and dBA, plus DC measurement.
- **Global Record.** Long-term recording of all channels at lowest system load.
- **Completely multi-client.** Open as many measurement windows as you like, on any channels and inputs or outputs!

To install DIGICheck, go to [www.rme-audio.com](http://www.rme-audio.com), section **Downloads / DIGICheck**. Download the latest version, unzip and run *setup.exe*. Follow the instructions prompted on the screen.



---

## User's Guide



# ADI-2 DAC

### ► Installation and Operation – Mac OS X

---

## 24. General

The ADI-2 DAC is a UAC 2.0 Class Compliant device. Mac OS X has full UAC support built-in, there is no driver installation required. Connect computer and ADI-2 DAC with a USB cable. Mac OS X detects the new hardware as **ADI-2 DAC (serial number)**.

For **firmware updates** please see chapter 7.

### 24.1 Configuring the ADI-2 DAC

Configuration of the ADI-2 DAC is mostly done directly at the unit. When set to Clock Source Internal, Mac OS X will set the current sample rate.

Via **Launchpad – Other – Audio MIDI Setup** the ADI-2 DAC can be configured for the system wide usage. The Audio window allows to select the sample rate, up to 768 kHz.

Use **Configure Speakers** to freely configure the stereo playback to any available channels.

Applications that don't support card or channel selection will use the device chosen as **Input** and **Output** in the **System Preferences – Sound** panel. This setting is also available in the Audio MIDI Setup via the gear symbol at the bottom of the window.

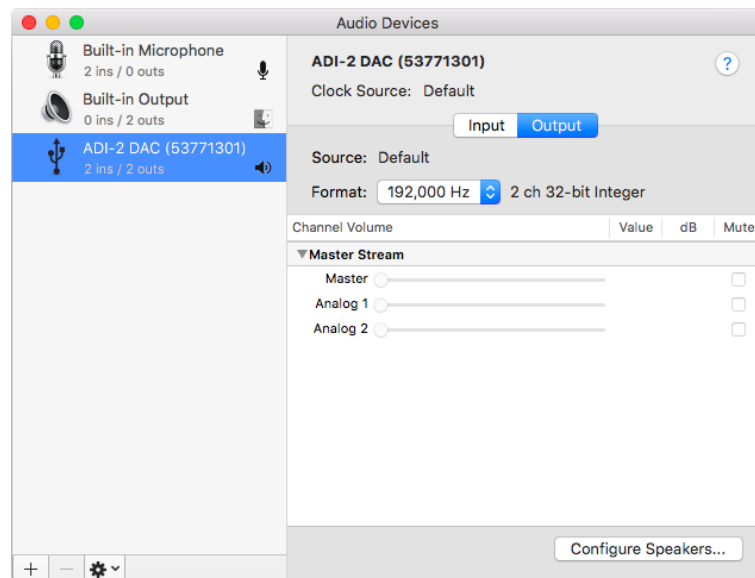

### 24.2 Clock Modes - Synchronization

In the digital world, all devices must be either Master (clock source) or Slave (clock receiver). Whenever several devices are linked within a system, there must always be a single master clock.

! *A digital system can only have one master! If the ADI-2 DAC's clock mode is set to 'Internal', all other devices must be set to 'Slave'.*

To cope with some situations which may arise in studio practice, defining a sync reference is essential. RME's exclusive **SyncCheck** technology enables an easy to use check and display of the current clock status. In the State Overview screen the column SYNC will show for all digital inputs whether there is a valid signal (Lock, No Lock) for the optical input, or if there is a valid *and* synchronous signal (Sync). See chapter 15.3.

---

## 24.3 Multi-interface Operation

OS X supports the usage of more than one audio device within an audio software. This is done via the Core Audio function **Aggregate Devices**, which allows to combine several devices into one. All units have to be in sync, i.e. have to receive valid sync information via a digital input signal, then all channels can be used at once.

If one of the devices is set to clock mode Master, all others have to be set to clock mode Slave, and have to be synced from the master by feeding AES, SPDIF or ADAT. The clock modes of all units have to be set up correctly in their Settings dialog.

## 25. DIGICheck Mac

The DIGICheck software is a unique utility developed for testing, measuring and analysing digital audio streams. Although this software is fairly self-explanatory, it still includes a comprehensive online help. DIGICheck 0.73 operates in parallel to any software, currently only showing the SPDIF input data. The following is a short summary of the currently available functions:

- **Level Meter.** High precision 24-bit resolution, 2 channels. Application examples: Peak level measurement, RMS level measurement, over detection, phase correlation measurement, dynamic range and signal-to-noise ratios, RMS to peak difference (loudness), long term peak measurement, input check. Oversampling mode for levels higher than 0 dBFS. Supports visualization according to the K-System.
- **Spectral Analyser.** World wide unique 10-, 20- or 30-band display in analog bandpass filter technology. 192 kHz-capable!
- **Vector Audio Scope.** World wide unique Goniometer showing the typical afterglow of a oscilloscope-tube. Includes Correlation meter and level meter.
- **Totalyser.** Spectral Analyser, Level Meter and Vector Audio Scope in a single window.
- **Surround Audio Scope.** Professional Surround Level Meter with extended correlation analysis, ITU weighting and ITU summing meter.
- **ITU1770/EBU R128 Meter.** For standardized loudness measurements.
- **Bit Statistics & Noise.** Shows the true resolution of audio signals as well as errors and DC offset. Includes Signal to Noise measurement in dB and dBA, plus DC measurement.
- **Completely multi-client.** Open as many measurement windows as you like, on any channels and inputs or outputs!

To install DIGICheck, go to [www.rme-audio.com](http://www.rme-audio.com), section **Downloads / DIGICheck**. Download the latest version, unzip and run the installer. Follow the instructions prompted on the screen.

Note: The newer, more modern and much more flexible version **DigiCheck NG** for Intel and M1 Macs is now also available on the RME website.





---

## User's Guide



# ADI-2 DAC

## ► Installation and Operation – iOS

---

## 26. General

The ADI-2 DAC operates in **Class Compliant** mode (UAC 2.0), a standard that is natively supported by operating systems like iOS, Mac OS X, Linux and Windows 10 (since 1709). No proprietary drivers are required, the device will be directly recognized.

The ADI-2 DAC provides iOS devices with the professional I/O connections they lack. Professional balanced and unbalanced line outputs, two Extreme Power and IEM headphone outputs that excel with both high and low impedance headphones, extensive gain and level adjustments, SPDIF input, PCM playback at up to 768 kHz, and DSD playback at up to 11.2 MHz (DSD256). An app like *Neutron* can actually play files with up to 768 kHz sample rate and DSD 256 natively via the ADI-2 DAC in Basic Mode Stereo.

The ADI-2 DAC does not supply power to the iPad/iPhone. The latest Lightning to USB 3 Camera adapter from Apple includes a Lightning socket to connect the standard Apple power supply, allowing to charge the i-device while it operates in Class Compliant mode with the ADI-2 DAC.

## 27. System requirements for iOS Operation

- Any Apple iPad with at least iOS 5 or an iPhone with at least iOS 7
- Apple iPad Camera Connection Kit or Lightning to USB adapter
- iPad Pro: no active adapter, just a simple USB-B to USB-C cable or connector adapter

## 28. Setup

Connect the USB cable to the Camera Connection Kit/Lightning adapter/iPad Pro. Start the i-device and plug the Kit/adapter into the i-device's socket. If everything works as expected, the unit will be used for all audio I/O. Audio playback in iTunes will automatically be performed by the ADI-2 DAC.

Note: The i-device's volume control is inactive during USB operation.

## 29. Notes

In Class Compliant mode the default clock mode is *Internal*, and iOS typically sets the highest available sample rate. Any app can change / set the sample rate to a desired value, but not all apps include a choice to select one. Setting the ADI-2 DAC (and with it the i-device) to slave mode by selecting the SPDIF input as clock source, the ADI-2 DAC will be synchronized to the external digital sample rate. With a wrong external sample rate heavy audio noise will occur. Without an external signal the ADI-2 DAC changes to its internal clock, with the sample rate set by iOS or the app in use.

---

## User's Guide



# ADI-2 DAC

## ► Technical Reference

---

## 30. Technical Specifications

### 30.1 Digital Inputs

#### General

- Lock Range: 32 kHz – 200 kHz
- Jitter suppression: > 50 dB (2.4 kHz)
- Accepts Consumer and Professional format

#### SPDIF coaxial

- 1 x RCA, according to IEC 60958
- High-sensitivity input stage (< 0.3 Vpp)
- AES/EBU compatible (AES3-1992)

#### SPDIF optical

- 1 x optical, according to IEC 60958
- ADAT compatible

### 30.2 Analog Outputs

#### XLR

- Output level switchable +19 dBu, +13 dBu, +7 dBu, +1 dBu @ 0 dBFS
- Signal to Noise ratio (SNR) @ +7/+13/+19 dBu: 120 dB RMS unweighted, 123 dBA
- Signal to Noise ratio (SNR) @ +1 dBu: 117 dB RMS unweighted, 120 dBA
- Frequency response @ 44.1 kHz, -0.1 dB: 0 Hz – 20.7 kHz
- Frequency response @ 96 kHz, -0.5 dB: 0 Hz – 46.1 kHz
- Frequency response @ 192 kHz, -1 dB: 0 Hz – 91.5 kHz
- Frequency response @ 384 kHz, -1 dB: 0 Hz – 173 kHz
- Frequency response @ 768 kHz, -3 dB: 0 Hz – 218 kHz
- THD @ 0 dBFS: < -120 dB, 0.0001 %
- THD+N @ 0 dBFS: -116 dB, 0.00016 %
- Channel separation: > 120 dB
- Output impedance: 200 Ohm

#### RCA

As output XLR, but:

- Output: 6.3 mm RCA jack, unbalanced
- Output level 6 dB lower than XLR (-5 dBu to +13 dBu @ 0 dBFS)
- Signal to Noise ratio (SNR) @ +13 dBu: 120 dB RMS unweighted, 123 dBA
- Signal to Noise ratio (SNR) @ +1/+7 dBu: 116/119 dB RMS unweighted, 119/122 dBA
- Signal to Noise ratio (SNR) @ -5 dBu: 112 dB RMS unweighted, 114 dBA
- Output impedance: 100 Ohm

#### Phones

As XLR, but:

- Output: 6.3 mm TRS jack, unbalanced, stereo
- Output impedance: 0.1 Ohm
- Output level at 0 dBFS, High Power, load 100 Ohm or up: +22 dBu (10 V)
- Output level at 0 dBFS, Low Power, load 8 Ohm or up: +7 dBu (1.73 V)
- Signal to Noise ratio (SNR) @ +22 dBu: 120 dB RMS unweighted, 123 dBA
- Signal to Noise ratio (SNR) @ +7 dBu: 118 dB RMS unweighted, 121 dBA
- THD @ +18 dBu, 32 Ohm load, 1.2 Watt: -120 dB, 0.0001 %
- THD+N @ +18 dBu, 32 Ohm load: -114 dB, 0.0002 %
- THD @ +14 dBu, 16 Ohm load, 0.94 Watt: -110 dB, 0.0003 %
- Max power @ 0.001% THD: 1.5 W per channel

## IEM

As Phones, but:

- Output level at 0 dBFS: -3 dBu, 0.55 V
- Signal to Noise ratio (SNR) @ -3 dBu: 118 dB RMS unweighted, 121 dBA
- Max power, 8 Ohm, 0.001% THD: 40 mW per channel

## 30.3 Digital

- Clocks: Internal, SPDIF In
- Jitter suppression of external clocks: > 50 dB (2.4 kHz)
- Effective clock jitter influence on DA conversion: near zero
- PLL ensures zero dropout, even at more than 100 ns jitter
- Additional Digital Bitclock PLL for trouble-free varispeed ADAT operation
- Supported sample rates for external clocks: 44 kHz up to 200 kHz
- Internally supported sample rates: 44.1 kHz up to 768 kHz

## 30.4 General

- Included power supply: external switching PSU, 100 - 240 V AC, 2 A, 24 Watts
- Standby power consumption: 120 mW (10 mA)
- Idle power consumption: 7 Watts, Max. power consumption: 18 Watts
- Idle current at 12 V: 570 mA (6.8 Watts)
- Dimensions (WxHxD): 215 x 52 x 150 mm (8.5" x 2.05" x 5.9")
- Weight: 1.0 kg ( 2.2 lbs)
- Temperature range: +5° up to +50° Celsius (41° F up to 122°F)
- Relative humidity: < 75%, non condensing

## 30.5 Connector Pinouts

### XLR Connectors

The XLR sockets of the analog outputs are wired according to international standards:  
1 = GND (Shield), 2 = + (hot), 3 = - (cold).

- *The **XLR outputs** do not operate servo-balanced! When connecting unbalanced equipment, make sure pin 3 of the XLR output is not connected. A connection to ground might cause higher THD (distortion) and power consumption!*

### TRS Phones jack

The analog output channels feed two **Phones** outputs via two independent driver circuits.

In case these outputs should operate as Line outputs, an adapter TRS plug to RCA phono plugs, or TRS plug to TS plugs is required.

The pin assignment follows international standards. The left channel is connected to the tip, the right channel to the ring of the TRS jack/plug.

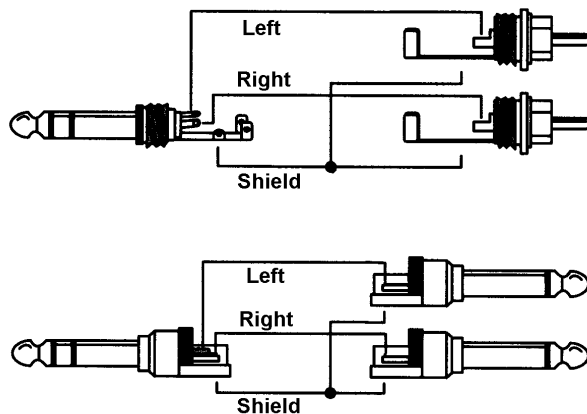

---

## 31. Technical Background

### 31.1 Emphasis

In the early times of digital audio, with AD and DA converters of only 14 bit resolution, a technique was used that is also known from radio transmission: pre- and de-emphasis. The audio signal is equalized to have treble boosted before the conversion. When played back an analog treble filter (the term high cut seems a bit strong) is required. Overall the audible noise and distortion caused by the AD and DA conversion was hoped to be reduced this way.

Some older CDs were recorded with Emphasis, and indeed Emphasis is part of the Red Book standard. Listening to them requires a filter on the playback side or their sound will seem too bright. The playback of older digital recordings from tape might also require de-emphasis, and even one of the first DAT recorders used Emphasis constantly.

Fortunately digital to analog converter chips have support for de-emphasis included. The ADI-2 DAC activates the DAC's de-emphasis automatically when the current source is AES or SPDIF and the Emphasis bit is set in the incoming Channel Status. The State Overview screen can be used to track this state, a WARNING SPDIF EMPHASIS message will be shown.

Why warning? Because when using the ADI-2 DAC as audio interface to record SPDIF into an audio file, the emphasis state is lost. Similarly there exists no mechanism to let the audio playback software control the emphasis state of the ADI-2 DAC during playback of that recorded file. An option *De-emphasis On* in the channel's I/O menu allows for a manual activation in such a case.

### 31.2 SteadyClock FS

RME's SteadyClock technology guarantees an excellent performance in all clock modes. Its highly efficient jitter suppression refreshes and cleans up any clock signal.

Usually a clock section consists of an analog PLL for external synchronization and several quartz oscillators for internal synchronization. SteadyClock requires one quartz only, using a frequency not equalling digital audio. Modern circuit designs like hi-speed digital synthesizer, digital PLL, 800 MHz sample rate and analog filtering allow RME to realize a completely newly developed clock technology, right within the FPGA at lowest costs. The clock's performance exceeds even professional expectations. Despite its remarkable features, SteadyClock reacts quite fast compared to other techniques. It locks in fractions of a second to the input signal, follows even extreme varipitch changes with phase accuracy, and locks directly within a range of 28 kHz up to 200 kHz.

The further improved SteadyClock FS technology attenuates even lowest frequency jitter (>1 Hz), provides an even higher jitter suppression at lowest self-jitter, and uses a low phase noise quartz with jitter in the range of femto seconds. Thanks to the highly efficient jitter suppression, the AD- and DA-conversion always operates on highest sonic level, being completely independent from the quality of the incoming clock signal.

SteadyClock has been originally developed to gain a stable and clean clock from the heavily jittery MADI data signal (the embedded MADI clock suffers from about 80 ns jitter). Using the input sources of the ADI-2 DAC, SPDIF, ADAT or AES, you'll most probably never experience such high jitter values. But SteadyClock is not only ready for them, it would handle them just on the fly.

## 31.3 DA Impulse Responses

Short delay Sharp

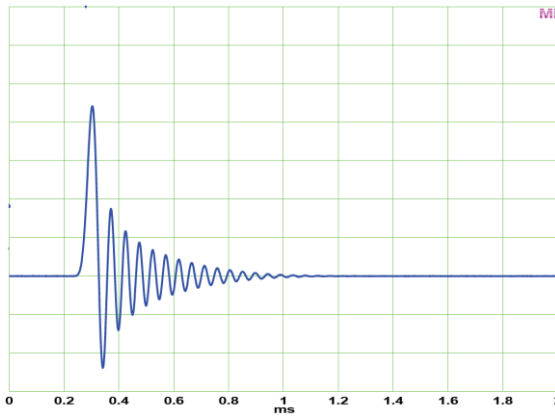

Sharp

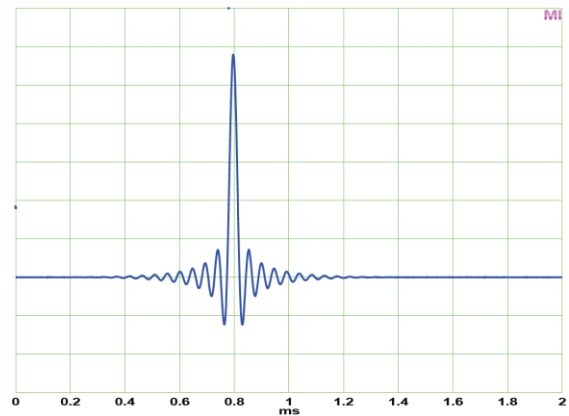

Short Delay Slow

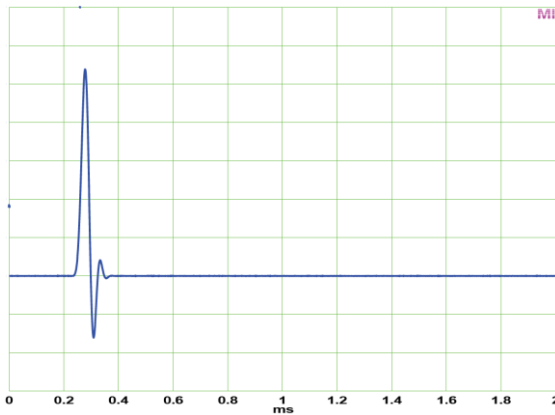

Slow

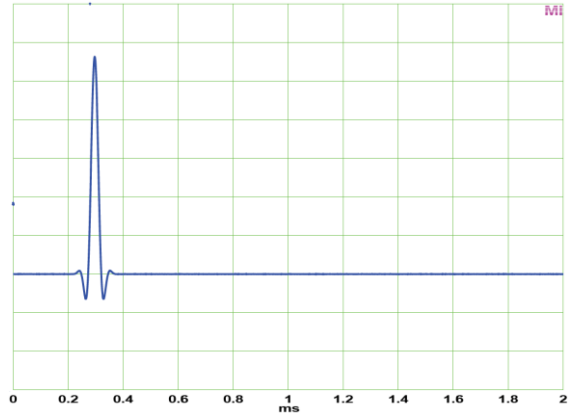

The screenshots above show the analog output signal of the DAC filters, stimulated by a digital single sample impulse at 44.1 kHz sample rate. While Slow has the most perfect response, it loses around 1.2 dB already at 15 kHz, see chapter 31.4. Both Short Delay are IIR filters, the other two are FIR type. FIR is phase linear over the whole frequency range.

### NOS (Non-Oversampling, SuperSlow)

The DAC includes another filter which is called *Super Slow* in its data sheet. The impulse response looks perfect, but checking the output signal with an Oscilloscope reveals steps that are more typical for so called Non-OverSampling (NOS) devices, so we renamed it *NOS* within the DAC filter menu. Note that there is no audible distortion, the steps equal high frequency harmonics that are mostly higher than 20 kHz. Please also note that Slow and NOS filters cause much more aliasing into the audio band and out-of-band noise than Sharp filters.

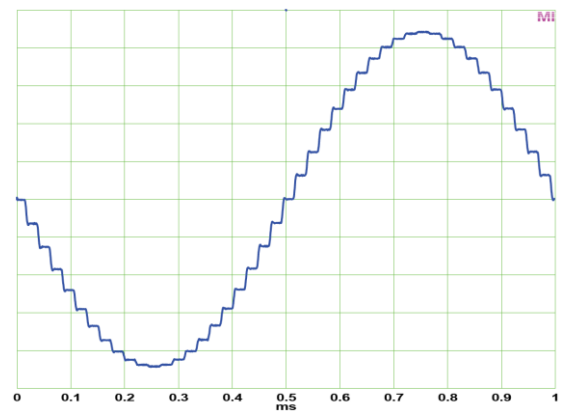
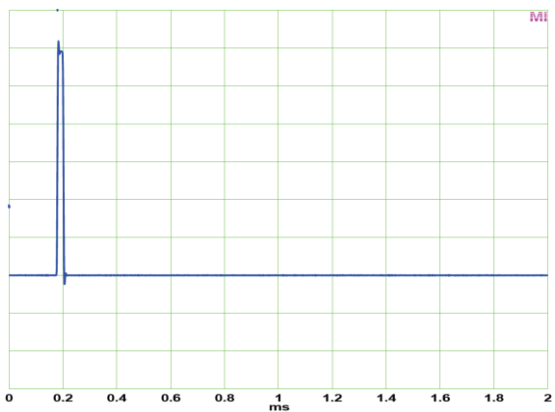

---

### SD LD (Short Delay Low Dispersion – only with AK4493 units)

In theory, a filter should have as little phase deviation as possible over the frequency range, have as short a settling time as possible, an acceptable decay time, and provide the maximum possible frequency range without deviation. The stopband attenuation should be high to prevent aliasing. A latency as low as possible would extend the application possibilities to more than just listening to music.

The filter with the bulky name *Short Delay Low Dispersion* approaches this ideal quite well. It does not have the early treble attenuation of the slow filters (see chapter 31.4), has a shorter settling time than Slow, an average decay time like Sharp, a phase maximum of only  $9^\circ$  at late 18 kHz (basically phase-linear in the audible range), and a latency of only 10 samples, so that it is also well suited for professional real-time monitoring. This makes it much more than just a successful compromise.

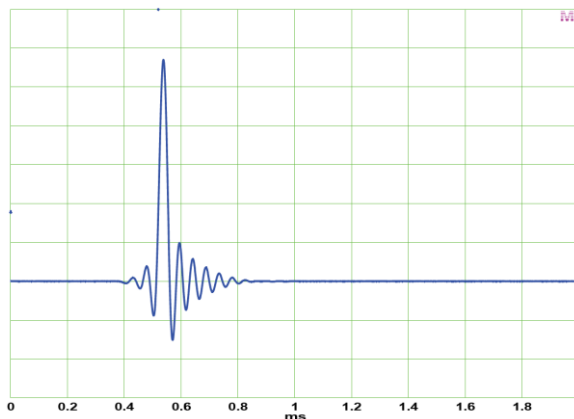

### Brickwall (only with ESS units)

In theory, a reconstruction filter should suppress all frequencies above half the sample rate, i.e. 22.05 kHz at 44.1 kHz. However, filters cannot be made infinitely steep without side effects. Therefore such filters, called *Brickwall*, usually already show slight level loss at 20 kHz (see chapter 31.4). To solve this issue the filters have been shifted a bit upwards - instead of 22.05 kHz, the maximum suppression is reached at 24 kHz. Advantage: the frequency response for the 20 kHz, usually declared as listening range, is as straight as a ruler. Disadvantage: the unfiltered range 22.05 kHz to 24 kHz produces mirror frequencies below 22.05 kHz, down to 20 kHz.

In practice, this is not a problem. In the range 22.05 kHz to 24 kHz there are normally no relevant signal components on a recording with 44.1 kHz sample rate, and even if there are, the mirrored signals are still in the inaudible range above 20 kHz. The whole industry therefore mainly uses somewhat too 'wide' filters on the DA side.

Unlike the AKM chip the ESS chip supports loading of custom filters. RME has calculated the filters SD Slow and NOS for the ESS chip, the filter coefficients are transferred to the chip during operation. On this occasion the not very popular SD LD has been replaced by the often requested Brickwall, which was also calculated and programmed by RME.

Brickwall is a phase-linear filter.

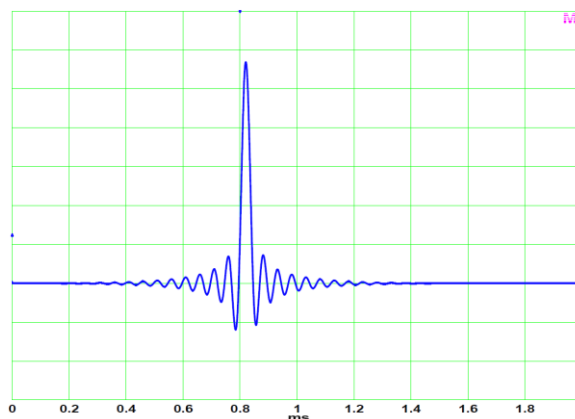



### 31.4 DA Filter Curves 44.1 kHz

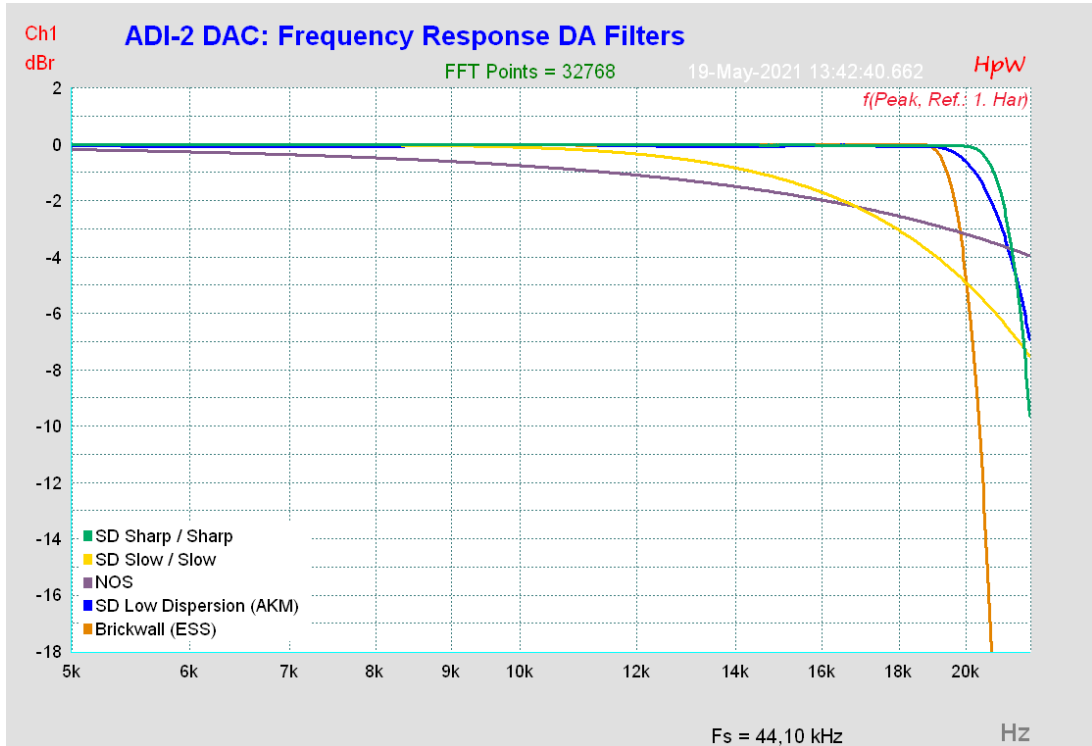

Notes: Sharp/SD Sharp and Slow/SD Slow are congruent. NOS shows a very early drop. SD Low Dispersion only in AKM chip units. Brickwall only in ESS chip units.

### 31.5 No Content - reserved

### 31.6 Loudness

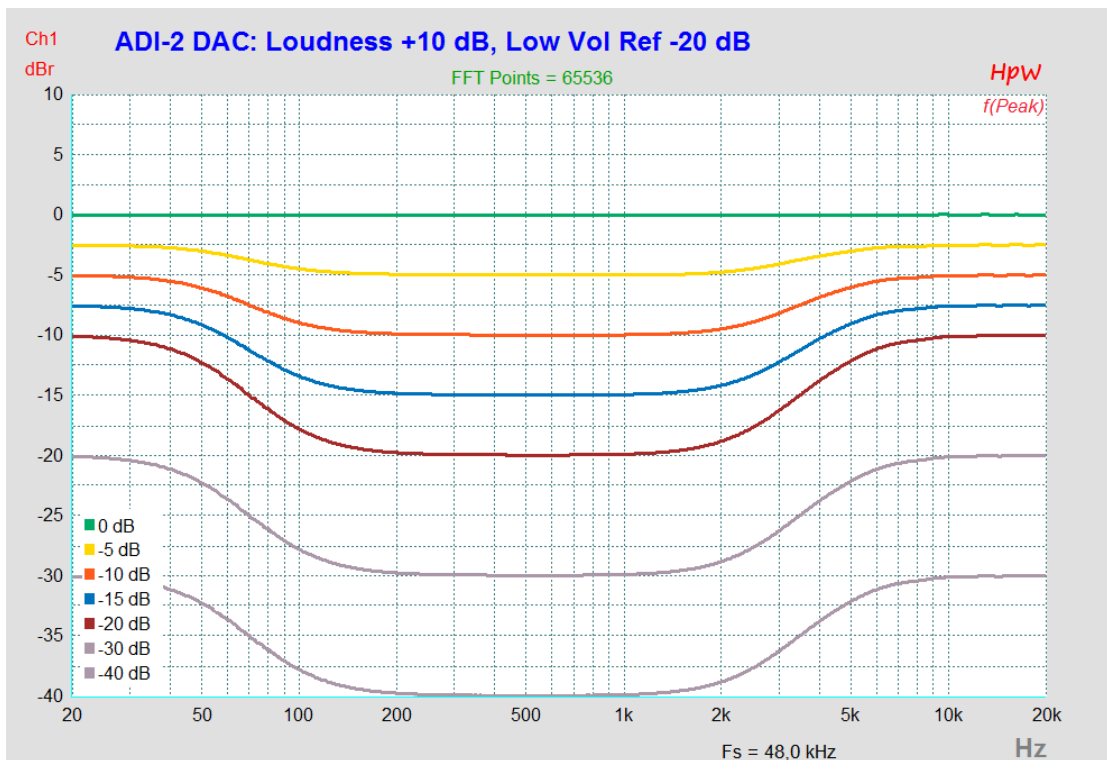

## 31.7 Distortion Measurements

### Outputs XLR and TS\*

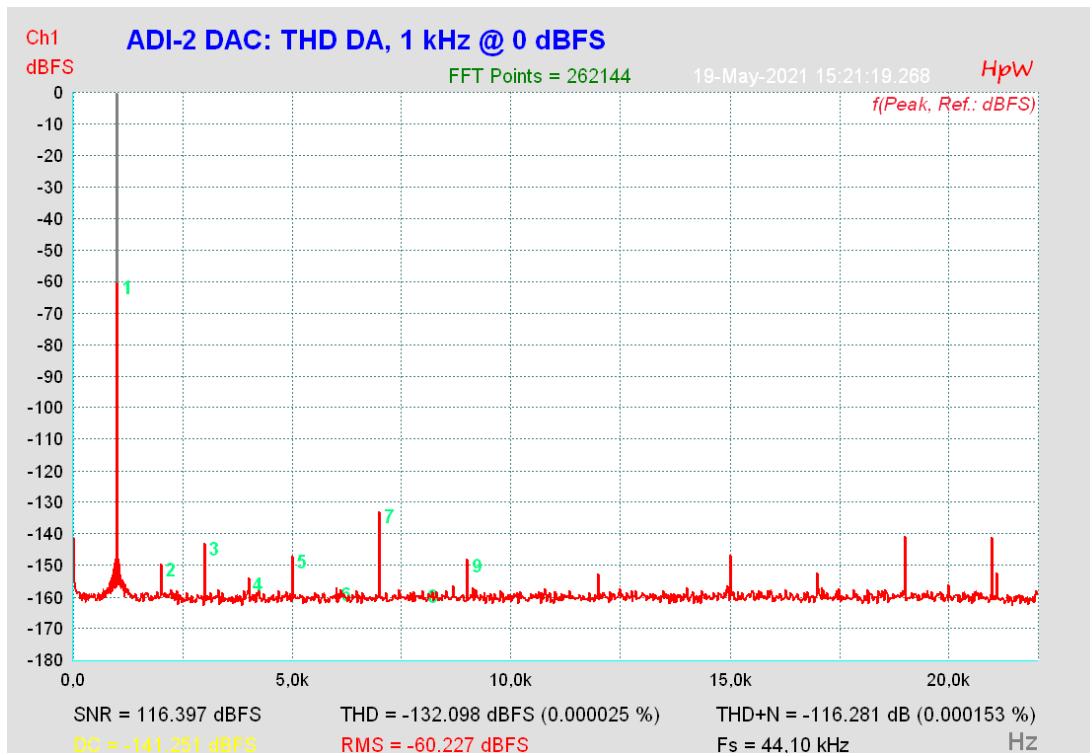

### Output Phones TRS\* \*\*

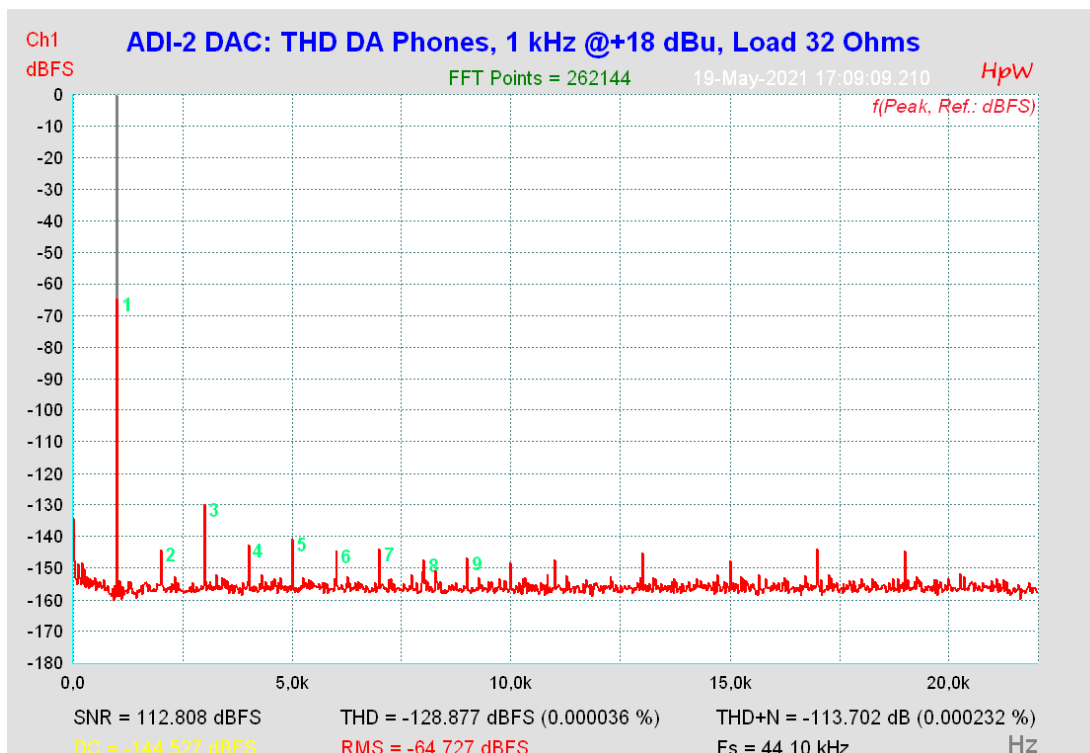

\* Measured with active notch filter via ADC of ADI-2 Pro FS

\*\* 18 dBu output level equal 1.2 W (per channel)

## 31.8 Extreme Power Charts

Extreme Power: Power vs Impedance

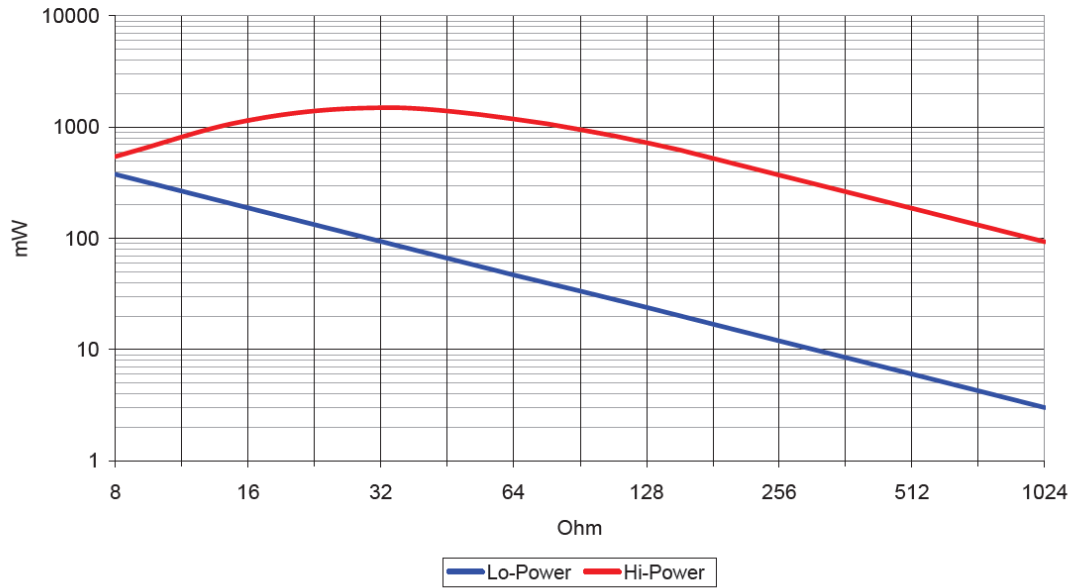

Extreme Power: Current / Voltage vs Impedance

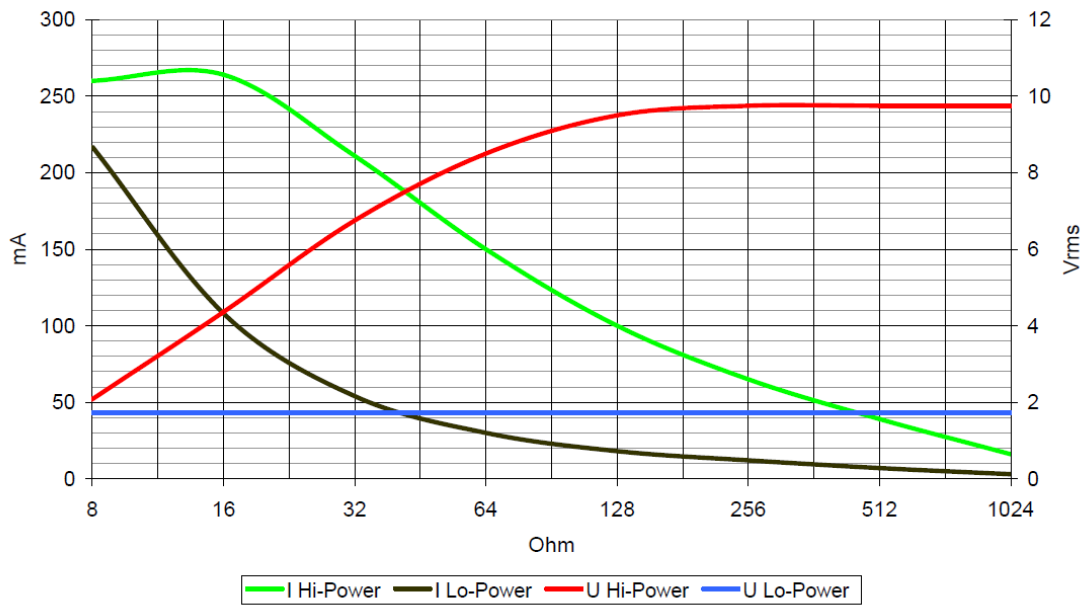

## 31.9 Phones Distortion Comparison

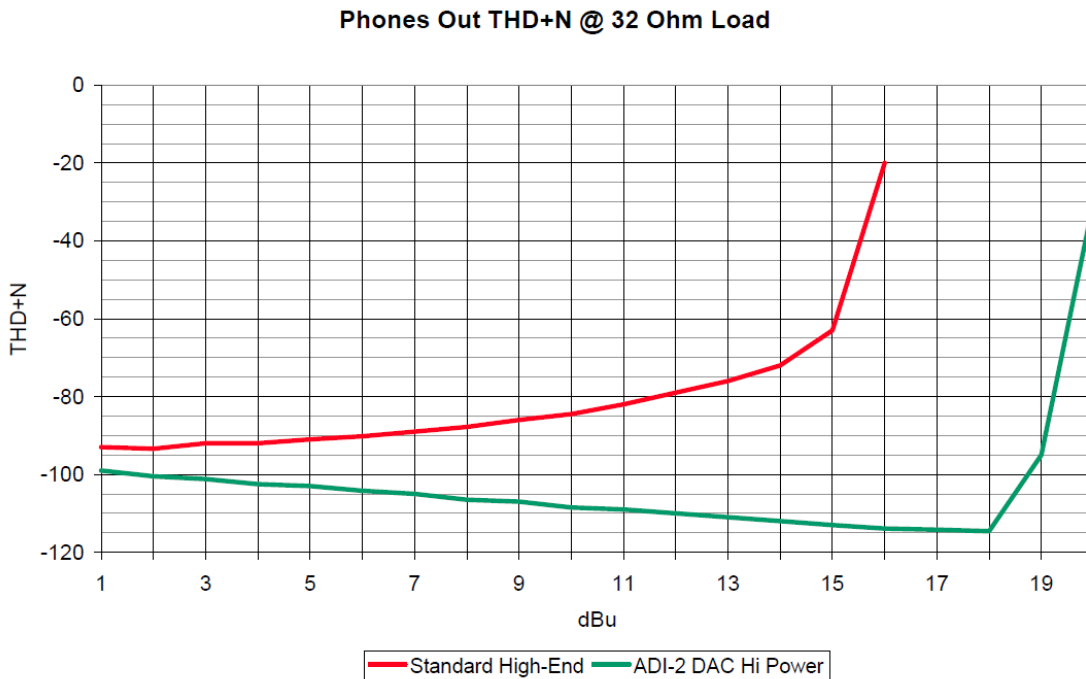

### 31.10 Impedance based Level Meters (Phones)

The horizontal level meters in various screens of the analog outputs show the digital level fed to the DAC. With loads higher than 32 Ohms the level meter's display matches the real analog output level (0 dBFS = +22 dBu). But at 32 Ohms the ADI-2 DAC delivers only +19 dBu, at 16 Ohms +15 dBu to the phones outputs, because a reasonable current limiting circuit prevents a too high output power at lower load impedances. When in Hi-Power mode, the highest undistorted value at 16 Ohms is -7 dB on the level meter. Consequently it should either change its colour to red then, or rescale the highest level to -7. Only then the user would be clearly informed which maximum level can be issued by the device undistorted.

As the current limiter of the Extreme Power output stages operates in finer resolution, its reaction can be evaluated dynamically and be used as simplified impedance detection. Which can then be used to re-scale the level meters.

Exactly that happens fully automated within the ADI-2 DAC. The peak values and the bar still show the original level information, but the meter's yellow and red areas get shifted and extended to the left.

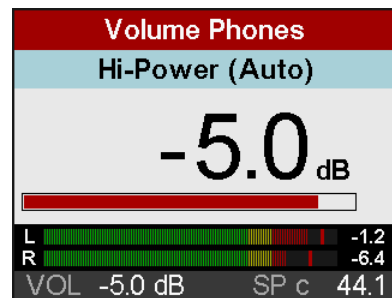

With revised volume settings, where the level meter stays below the red area, the user can now be 100% sure that the ADI-2 DAC operates absolutely free of distortion, even in the most extreme applications.

**Notes on functionality:** The re-scaling happens not before the highest undistorted level is exceeded. The re-scaling stays visible until the phones plug has been removed. An ongoing overload situation causes the activation of the Overload warning screen and a disconnection of the phones output.

---

## 31.11 USB Audio

An ADI-2 DAC can achieve a performance similar to a PCI or PCI Express based soundcard when used with an optimal PC. Low CPU load and click-free operation even at 64 samples buffer size are indeed possible on current computers. However, using older computers a simple stereo playback will begin to cause a CPU load of more than 30%.

A computer blocked for a short time – no matter if ASIO or WDM – will lose one or more data packets. Such problems can only be solved by increasing the buffer size (and with this the latency).

The ADI-2 DAC features a unique data checking, detecting errors during transmission via USB and displaying them in the Settings dialog. Additionally the ADI-2 DAC provides a special mechanism to continue recording and playback in case of drop-outs, and to correct the sample position in real-time.

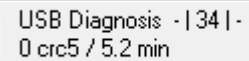

USB Diagnosis - | 34 | -  
0 crc5 / 5.2 min

Like any audio interface the ADI-2 DAC should have a data transmission to the computer as undisturbed as possible. The easiest way to guarantee this is to connect it to its own bus, which should be no big problem as most USB 2.0 interfaces are a double bus design. A check in the Device Manager can be done as follows:

- Connect the ADI-2 DAC to a USB port
- Start the Device Manager, View set to Devices by Connection
- Select ACPI x86-based PC, Microsoft ACPI-Compliant System, expand PCI Bus

This branch normally includes two entries of a *USB2 Enhanced Host Controller*. A USB Root Hub can be seen, which then connects all USB devices, including the ADI-2 DAC. By reconnecting to a different port this view immediately shows at which of the two controllers the ADI-2 DAC is connected. With multiple devices it can also be checked if they are connected to the same controller.

Furthermore this information can be used to operate an external USB drive without disturbing the ADI-2 DAC, by simply connecting the drive to the other controller. The information is also valid for USB 3 ports.

Especially with notebooks it can happen that all internal devices and all the sockets/ports are connected to the same controller, with the second controller not used at all. In that case all devices have to use the same bus and interfere with each other.

Experienced RME users remember the above text from the manuals of our other interfaces with lots of channels. Compared to these the ADI-2 DAC has two advantages:

- It uses an isochronous audio stream of only two channels (pretty ridiculous)
- It is not necessary to work at lowest latency. Setting the ASIO buffers to their highest value offers a much less critical and more stable recording and playback experience.

One should not underestimate the effect on higher sample rates with PCM and DSD, though. Those require to transfer data of multiples of the amount typical for a channel at 48 kHz:

Base	48 kHz	96 kHz	192 kHz/DSD64	384 kHz/DSD128	768 kHz/DSD256
Channels	2	4	8	16	32

---

## 31.12 Operation in the Hi-Fi Environment

### Do the advantages of the ADI-2 DAC's fully symmetrical design still exist when using unbalanced connections (RCA)?

Yes. On the output side RME uses a specially developed servo-balanced DAC filter, which provides both paths of the balanced design with full noise and distortion ratios. Therefore the technical specifications are reached even if the balanced XLR output is used unbalanced, disconnecting one pin - the required signal optimization is already done in the unit. At the RCA output an additional conversion balanced to unbalanced is performed directly at the output. These efforts guarantee the supreme sound quality of the ADI-2 DAC to be available in all operation and connection scenarios.

### Which level setting is recommended?

There are a total of four hardware reference levels available, with the XLR output having a 6 dB higher level. With Hi-Fi the setting +7 dBu (equals +4.78 dBV or 1.73 V RMS) is recommended. This setting causes an ADI-2 DAC to output level similar to that of many CD-players. In case it is still too low simply change to +13 dBu (+10.8 dBV, 3.46 V RMS).

### Doesn't a low hardware reference level cause a significant increase in noise?

Usually yes - but not with the ADI-2 DAC. Switching the reference levels is done in the analog domain, in hardware. The circuit has been optimized for maximum signal to noise ratio even at the lowest reference level, -5 dBu. Detailed values can be found in chapter 30.2.

### Fixed Output Level – Lock Volume

The option Lock Volume in the I/O menu allows to lock the analog output level to a specific value, a change via the VOLUME knob is no longer possible. The Volume adjustment within the menu is used to set the 'fixed' output level.

For example when the analog output should operate like a typical HiFi unit @ 2 V output level (equals +8 dBu), set the hardware Ref Level to +7 dBu and Volume to +1 dB. Or +13 dBu and Volume to -4.5 dB. More examples:

1 V (0 dBV, +2.2 dBu): Ref +7 dBu, Vol -5 dB

0.775 V (0 dBu, -2.2 dBV): Ref +1 dBu, Vol -1 dB

0.5 V (-3.8 dBu, -6 dBV): Ref +1 dBu, Vol -5 dB

0.315 V (-10 dBV, -7.8 dBu): Ref -5 dBu, Vol -3 dB

Note that most analog reference levels (except 2V) usually offer a lot of headroom. Therefore matching the levels to 0 dBFS might result in too low volume. Also note that the above table is no longer valid when PEQ and Bass/Treble are in use. The digital level will be higher and might even overload, which can be clearly seen on the output's level meter. Volume has to be further reduced then.

---

### 31.13 Digital Volume Control

The ADI-2 DAC deliberately avoids an analog level adjustment by means of a potentiometer. Its digital version surpasses an analog one in practically every conceivable point. Typical disadvantages of setting with potentiometers:

- Synchronicity errors lead to panoramic shifts and significant volume deviations left / right, in particular near the end points of the adjustment range.
- In the middle setting range, there is an increased crosstalk and changes in the frequency response. Changes in the frequency response also occur at the end regions of the adjustment path.
- The setting range for optimum volume adjustment is often too small, or at the lower or upper end of the potentiometer's adjustment range.
- Non-reproducible settings (except 0 and 11).
- Higher THD/THD+N. A point well known to measurement technicians. As soon as an analog potentiometer is in the signal path, the unstable contact between wiper and resistive track causes noise, which contains both THD (distortion) and N (noise), even in the stationary state. Thus the -110 dB of a DAC quickly gets reduced to for example -80 or -70 dB.

Special volume ICs, which activate different resistance values by means of numerous electronic switches, avoid some of the above mentioned points. Unfortunately, even the best of these ICs do not achieve either THD or dynamics of the DACs used in the ADI-2 DAC, thus would affect its analog output signal.

*However, none of this is an issue with RME's digital volume control!*

In fact an analog volume control has a (theoretical) advantage in only one point, namely the maximum signal to noise ratio at a higher level reduction. In reality, current circuitry overturns the theory, and the SNR at the output of such a device is no better than that of a digitally controlled one. This is even more true the better the DA converter works and the less noise it has - just like the ADI-2 DAC, which provides the maximum noise ratio over a wide level range of 20 dB, thanks to its four reference levels realized in the analog domain.

The most often cited issue of a digital volume control is an alleged loss of resolution at higher attenuation. An example: 117 dB dynamic roughly equals 19 bit resolution. A volume attenuation of 48 dB (8 bit) leaves 11 bit of resolution. Such a simple, but important details omitting argumentation, usually ends with: the music must sound distorted in quieter parts, and the signal to noise ratio is down to a useless 69 dB.

The former is simply wrong, the latter irrelevant in practice. Indeed there is a reduced signal to noise ratio, but it doesn't matter, as the noise was not audible before (below the hearing threshold), and is still not audible after lowering the level. And the reduced SNR also applies to devices with potentiometers, since the potentiometer is never placed at the output, but in the middle of the circuit, followed by further electronics which also add some basic noise.

The quality of the ADI-2 DAC's digital volume control is best shown by measurements. Hard times coming up for convinced supporters of the analog control, because here it is very clear that the disadvantages of a digital volume adjustment, such as roughness and distortions at higher attenuation, simply do not exist - at least with RME.

The following measurement shows a digital full-scale sine of 1 kHz, 16 bits without dither, which is reduced in level by 40 dB. Also shown are a full-scale sine of 1 kHz with 24 bit, at 60 dB and 93.8 dB level attenuation, which is the lowest volume setting the ADI-2 DAC offers.

A high-resolution FFT like HpW Works makes it possible to disassemble the signal into individual frequencies, and to identify unwanted components down to a level of -190 dBFS. The measurement shows that the undithered 16 bit signal does not produce any distortion or other tones above -170 dBFS. So at a volume setting of -40 dB the measurable THD is -130 dB. At 24 bit a volume setting of -60 dB also achieves -130 dB without distortion. And at a volume setting of -93.8 dB there are still -93 dB THD measurable.

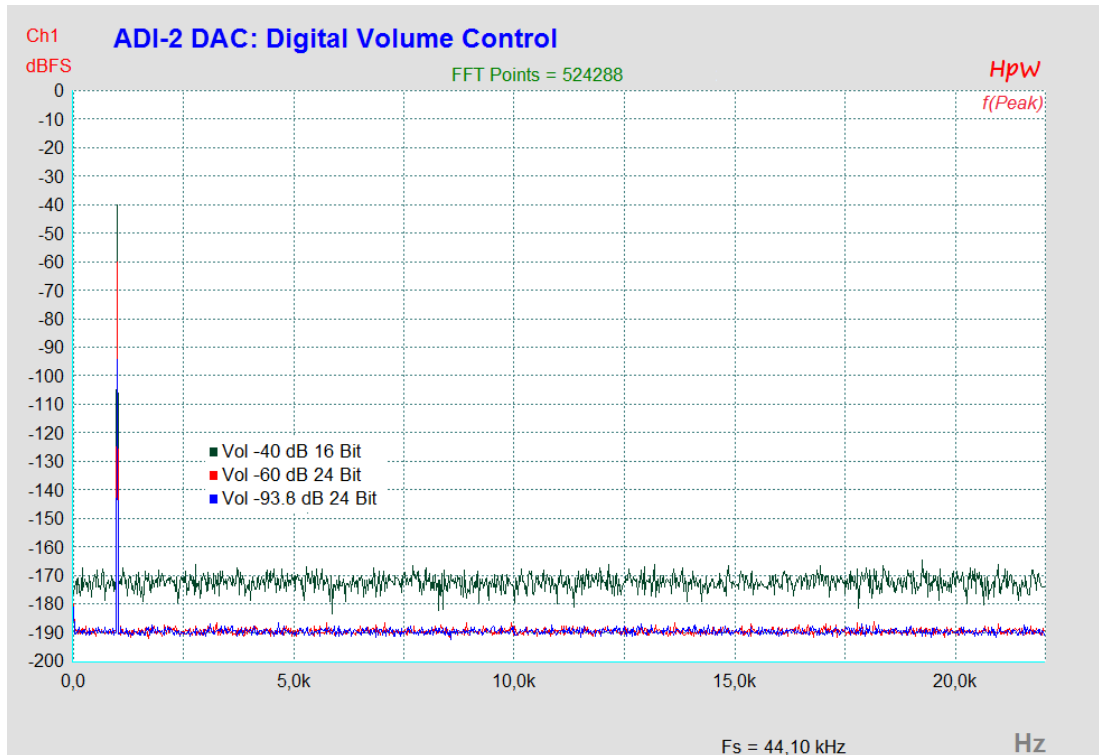

These results clearly show that distortion products of the digital volume control are not drowned by the DAC's noise, but are not generated at all. It works perfectly even with an undithered 16 bit signal, no detectable distortion products are produced.

If the volume control is measured at the analog output, the demonstrable THD is reduced to around -100 dB at a volume setting of -60 dB, by the self-noise of the DAC (SNR 117 dB RMS unweighted). In the above measurement that would be seen as straight noise floor at -160 dBFS. The digital volume control of the ADI-2 DAC therefore works much more precisely and cleaner than required for current top-level DACs.

In summary:

*RME's digital volume control in 42 bit TotalMix technology avoids all the disadvantages of analog level control via pots, is easy to use, offers reproducible settings, and the highest sound quality.*



---

## 31.14 Bit Test

A bit test is used to check the playback path for unwanted changes in the playback data. Playback software can cut bits, add dither, or change the level - without these changes becoming noticed easily. A poorly programmed driver can manipulate bits, and a playback hardware could be both badly designed and defective (hanging bits, swapped bits). Even such features as proper channel assignment, left/right synchronicity and polarity can be tested by a well-made bit test.

With a bit test, such errors can be detected and - more importantly - excluded.

### How does it work?

Most bit tests take some time and are loud and unpleasant when playing through headphones or speakers. RME uses a unique bit pattern, with defined levels and pauses. This consists of only 400 samples (<10 ms), and sounds like a dull, medium-loud click - harmless for ears and equipment. The short, but efficient test sequence allows to check for the following changes and errors:

Level changes, equalization, dynamic processing, polarity, channel swapping, sample offset, hanging or twisted bits, dither, bit reduction.

The signal reaches the ADI-2 DAC via USB, AES or SPDIF/ADAT. The unit has three continuously running check circuits. If the test signal is detected correctly, the device's display shows a message: *Bit Test 16 bits, 24 bits or 32 bits passed*, depending on the detected signal. If the transmission path is not bit-transparent or bit-accurate, the signal only minimally changed, the message is not shown, the bit test failed. There is no error notice.

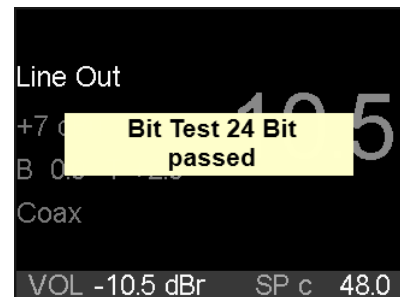

RME provides several audio files as free download: 44.1, 96 and 192 kHz in 16 bit, 24 bit and 32 bit. These files in WAV format can be played easily on Windows, Mac OS X and Linux. For ease of use (looping, players with fade in/out), the files contain the bit pattern several times. Runtime is about 4 seconds.

Download:

[http://www.rme-audio.de/download/bit\\_test\\_wavs.zip](http://www.rme-audio.de/download/bit_test_wavs.zip)

The Zip archive contains:

441_16_adi2pro_bittest.wav	441_24_adi2pro_bittest.wav	441_32_adi2pro_bittest.wav
48_16_adi2pro_bittest.wav	48_24_adi2pro_bittest.wav	48_32_adi2pro_bittest.wav
96_16_adi2pro_bittest.wav	96_24_adi2pro_bittest.wav	96_32_adi2pro_bittest.wav
192_16_adi2pro_bittest.wav	192_24_adi2pro_bittest.wav	192_32_adi2pro_bittest.wav

Theoretically, the use of the 32 bit file is sufficient. If the lower bits on the transmission path are simply truncated, the corresponding message appears with the respectively recognized bit resolution, i.e. 24 or 16 bits.

### Notes:

- iOS, AES, SPDIF and ADAT are limited to 24 bit.
- Some players in Mac OS X offer a Direct Mode, using 32 bit integer in non-mixable format. The 32 bit test might still fail. HQPlayer 3.20 and up is known to pass.
- SPDIF/ADAT (AES) are checked behind clocking. Therefore the unit needs to be synchronized correctly to the digital input signal.

### 31.15 Block Diagram

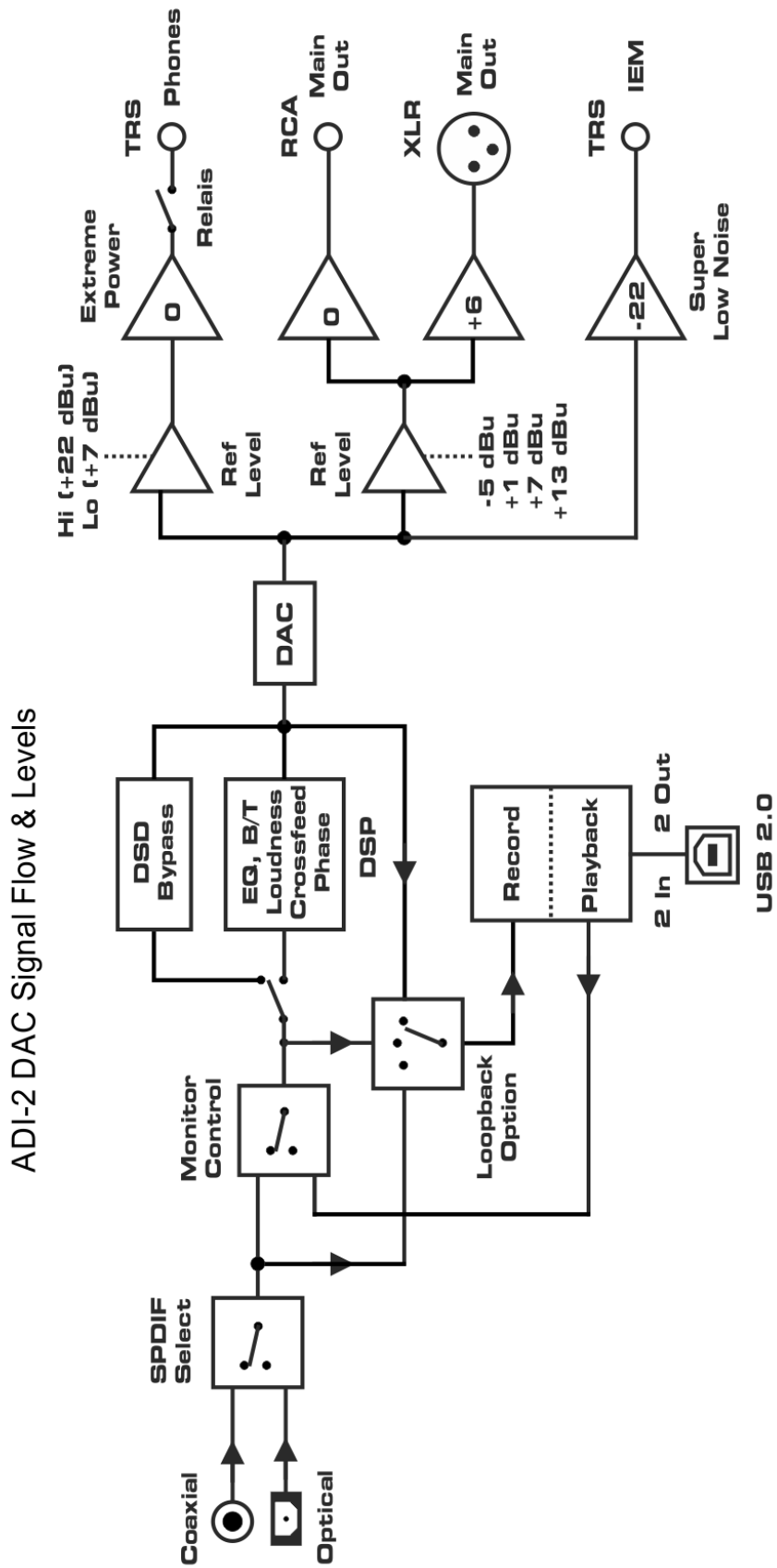

---

## User's Guide



# ADI-2 DAC

## ► Miscellaneous

---

## 32. Accessories

There are several items available for the ADI-2 DAC:

<b>Part Number</b>	<b>Description</b>
NT-RME-2 (lockable)	Power supply for ADI-2 DAC. Robust and light-weight switching power supply, 100 V-240 V AC, 12 V 2 A DC. Lockable DC connector.
USB Cable, 2m	RME USB 2 cable, length 78" (2m)
MRC	RME Multi Remote Control, infrared remote control

Optical cables for SPDIF and ADAT operation:

OK0100PRO	Optical cable, TOSLINK, 1 m (3.3 ft)
OK0200PRO	Optical cable, TOSLINK, 2 m (6.6 ft)
OK0300PRO	Optical cable, TOSLINK, 3 m (9.9 ft)

## 33. Warranty

Each individual ADI-2 DAC undergoes comprehensive quality control and a complete test before shipping. The usage of high grade components should guarantee a long and trouble-free operation of the unit.

If you suspect that your product is faulty, please contact your local retailer. Do not open the device by yourself as it may get damaged. It has been sealed with tamper-evident material, and your warranty is void if those seals have been damaged.

Audio AG grants a limited manufacturer warranty of 6 months from the day of invoice showing the date of sale. The length of the warranty period is different per country. Please contact your local distributor for extended warranty information and service. Note that each country may have regional specific warranty implications.

In any case warranty does not cover damage caused by improper installation or maltreatment - replacement or repair in such cases can only be carried out at the owner's expense.

No warranty service is provided when the product is not returned to the local distributor in the region where the product had been originally shipped.

Audio AG does not accept claims for damages of any kind, especially consequential damage. Liability is limited to the value of the ADI-2 DAC. The general terms of business drawn up by Audio AG apply at all times.

---

## 34. Appendix

RME news, driver updates and further product information are available on RME's website:

<https://www.rme-audio.com>

Worldwide distribution: Audio AG, Am Pfanderling 60, D-85778 Haimhausen, Tel.: (49) 08133 / 918170

Support via e-mail: [support@rme-audio.com](mailto:support@rme-audio.com)

List of international supporters: <https://www.rme-audio.de/support.html>

RME user forum: <https://forum.rme-audio.de>

### Acknowledgements

The Bauer Binaural Crossfeed effect in the ADI-2 DAC was inspired by Boris Mikhaylov's bs2b implementation.

### Trademarks

All trademarks, registered or otherwise, are the property of their respective owners. RME, DIGICheck and Hammerfall are registered trademarks of RME Intelligent Audio Solutions. SyncCheck, ZLM, DIGI96, SyncAlign, TMS, TotalMix, SteadyClock, ADI-2 DAC and Babyface Pro are trademarks of RME Intelligent Audio Solutions. Alesis and ADAT are registered trademarks of Alesis Corp. ADAT optical is a trademark of Alesis Corp. Microsoft, Windows 7/8/10 are registered trademarks or trademarks of Microsoft Corp. Apple, iPad, iPhone and Mac OS are registered trademarks of Apple Inc. ASIO is a registered trademark of Steinberg Media Technologies GmbH.

Copyright © Matthias Carstens, 07/2021. Version 2.8

Current driver version Windows: 0.9735

Firmware: FPGA 66, DSP 41, 07/2021

Although the contents of this User's Guide have been thoroughly checked for errors, RME can not guarantee that it is correct throughout. RME does not accept responsibility for any misleading or incorrect information within this guide. Lending or copying any part of the guide or the RME Driver CD, or any commercial exploitation of these media without express written permission from RME Intelligent Audio Solutions is prohibited. RME reserves the right to change specifications at any time without notice.

### Note on Disposal

According to the guide line RL2012/19EU (WEEE – Directive on Waste Electrical and Electronic Equipment), valid for all European countries, this product has to be recycled at the end of its lifetime.

In case a disposal of electronic waste is not possible, the recycling can also be done by Audio AG.

For this the device has to be sent **free to the door** to:

Audio AG  
Am Pfanderling 60  
D-85778 Haimhausen  
Germany



Shipments not prepaid will be rejected and returned on the original sender's costs.

---

## 35. Declaration of Conformity

### CE

This device has been tested and found to comply with the limits of the European Council Directive on the approximation of the laws of the member states relating to electromagnetic compatibility according to RL2014/30/EU, and European Low Voltage Directive RL2014/35/EU.

### FCC

This device complies with Part 15 of the FCC Rules. Operation is subject to the following two conditions: (1) This device may not cause harmful interference, and (2) This device must accept any interference received, including interference that may cause undesired operation.

Warning: Changes or modifications to this unit not expressly approved by the party responsible for compliance could void the user's authority to operate the equipment.

Responsible Party in USA:

Synthax United States, 6600 NW 16th Street, Suite 10, Ft Lauderdale, FL 33313  
T.:754.206.4220

Trade Name: RME, Model Number: ADI-2 DAC

This equipment has been tested and found to comply with the limits for a Class B digital device, pursuant to Part 15 of the FCC Rules. These limits are designed to provide reasonable protection against harmful interference in a residential installation. This equipment generates, uses, and can radiate radio frequency energy and, if not installed and used in accordance with the instructions, may cause harmful interference to radio communications. However, there is no guarantee that interference will not occur in a particular installation. If this equipment does cause harmful interference to radio or television reception, which can be determined by turning the equipment off and on, the user is encouraged to try to correct the interference by one or more of the following measures:

- Reorient or relocate the receiving antenna.
- Increase the separation between the equipment and receiver.
- Connect the equipment into an outlet on a circuit different from that to which the receiver is connected.
- Consult the dealer or an experienced radio/TV technician for help.

**Caution:** To comply with the limits of the Class B digital device, pursuant to Part 15 of the FCC Rules, this device must be operated with computer equipment certified to comply with Class B limits. All cables used to connect to the computer and peripherals must be shielded and grounded. Operation with non-certified computers or unshielded cables may cause interference to radio or television reception.

### RoHS

This product has been soldered lead-free and fulfils the requirements of the RoHS directive RL2011/65/EU.