

10" - 500W Bass Guitar Loudspeaker

10 BS 2,5 PL - 8 Ω

Code Z005910

GENERAL CHARACTERISTICS

Nominal Overall Diameter	268	mm
Nominal Voice Coil Diameter	65	mm
Magnet Weight	220	g
Flux Density.....	1.14	T
Weight.....	2.22	Kg

THIELE-SMALL PARAMETERS

Voice Coil DC Resistance	R_E	5.14	Ω
Resonance Frequency	f_s	57.6	Hz
Mechanical Q Factor.....	Q_{MS}	6.45	
Electrical Q Factor.....	Q_{ES}	0.47	
Total Q Factor	Q_{TS}	0.43	
Mechanical Moving Mass	M_{MS}	41.9	g
Mechanical Compliance	C_{MS}	180	μm/N
Force Factor	$B \times l$	12.94	Wb/m
Equivalent Acoustic Volume.....	V_{AS}	30.9	lt.
Maximum Linear Displacement	X_{MAX}	+/-5.0	mm
Reference Efficiency	η_0	1.22	%
Diaphragm Area	S_D	346.3	cm ²
Losses Electrical Resistance.....	R_{ES}	71.3	Ω
Voice Coil Inductance @ 1kHz	L_E	0.84	mH

CONSTRUCTIVE CHARACTERISTICS

Magnet.....	Neodymium
Voice Coil Winding.....	Copper
Voice Coil Former.....	Kapton
Cone	Paper
Surround.....	Treated Cloth
Dust Dome	Solid Paper
Basket	Aluminium Die-Cast

ELECTRICAL CHARACTERISTICS

Nominal Impedance.....	8	Ω
Musical Power	500	W
Rated Power*	250	W
Sensitivity @ 1 W, 1 m	95.0	dB

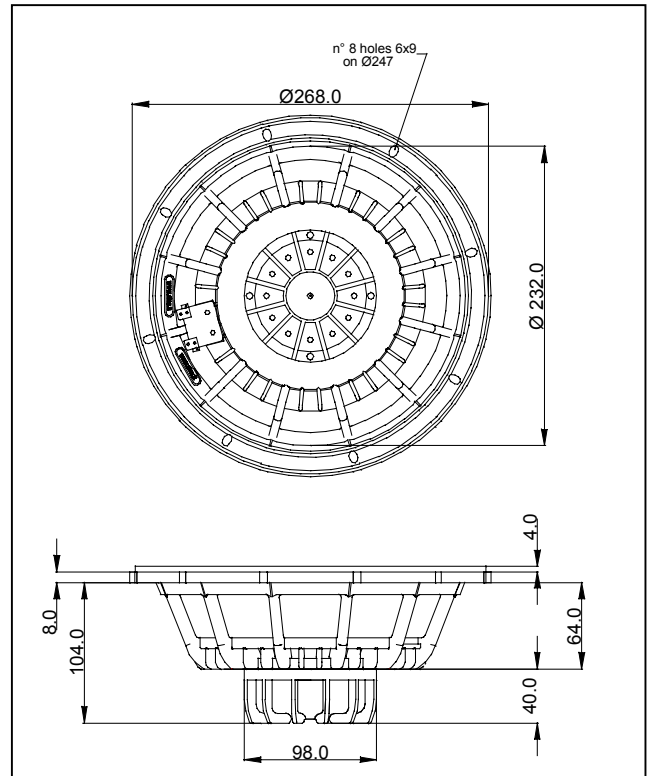

*rated power measured with 2 hours test with pink noise signal, 6 dB crest factor, loudspeaker mounted on enclosure
Thiele-Small parameters measured with LASER system

Frequency Response on IEC Baffle (DIN 45575) @ 1 W, 1 m - Impedance

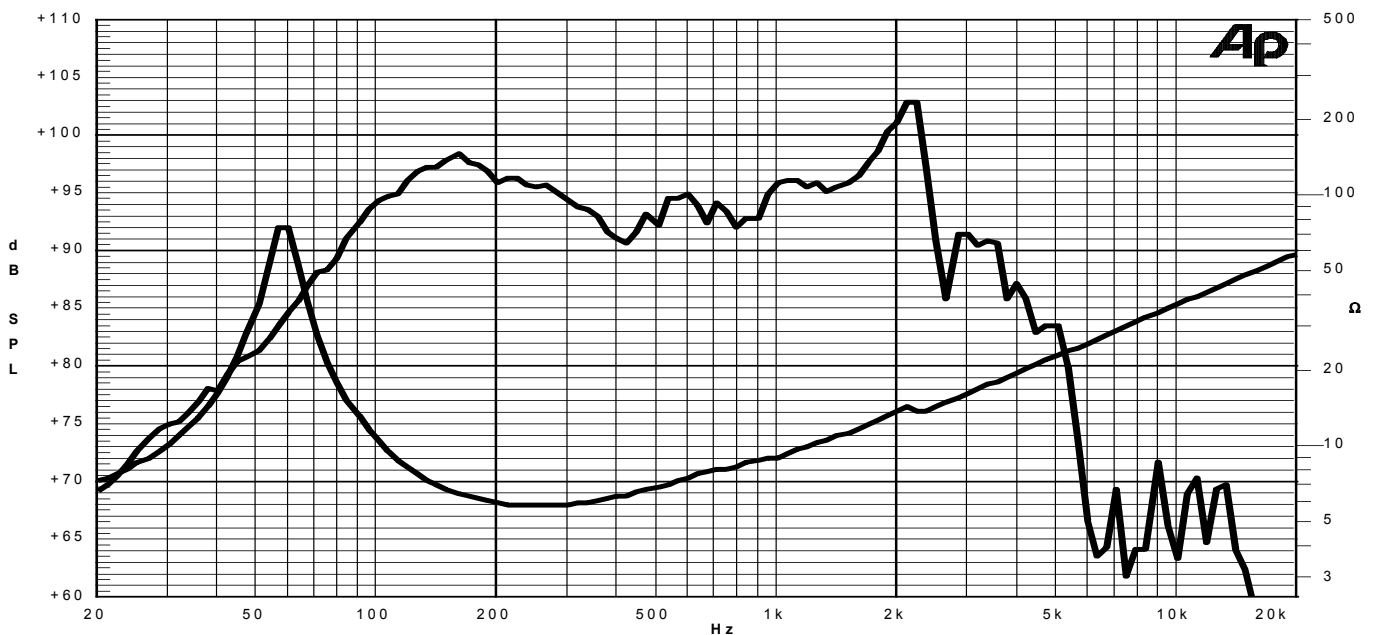

10 BS 2,5 PL

10" speaker – 2,5" voice coil

GRAPHICS AND MEASUREMENTS

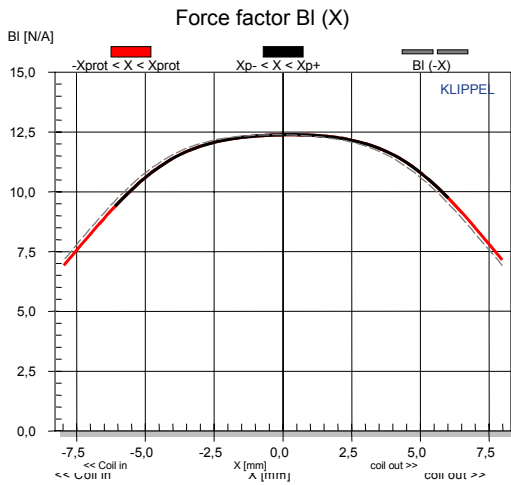

$BI(X)$: force factor variation with voice coil displacement

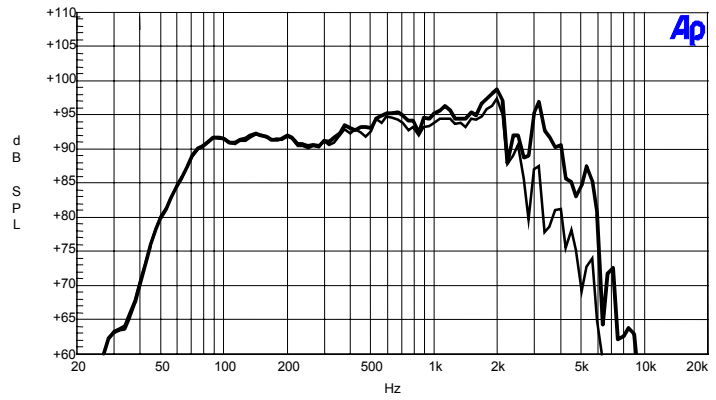

Frequency Response: enclosure volume 35l, port tuning 67Hz (thick curve on axis, thin curve 30° off axis)

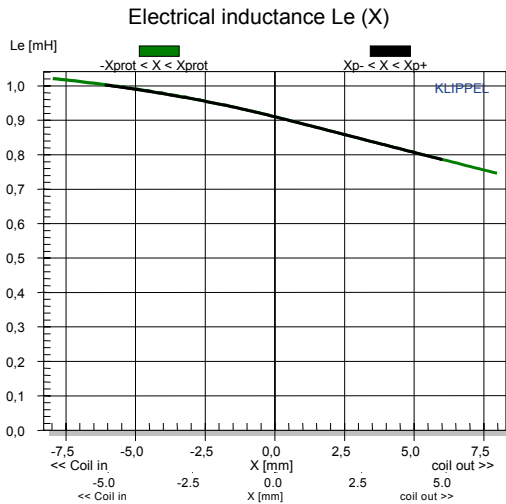

Le : electrical inductance variation with voice coil displacement

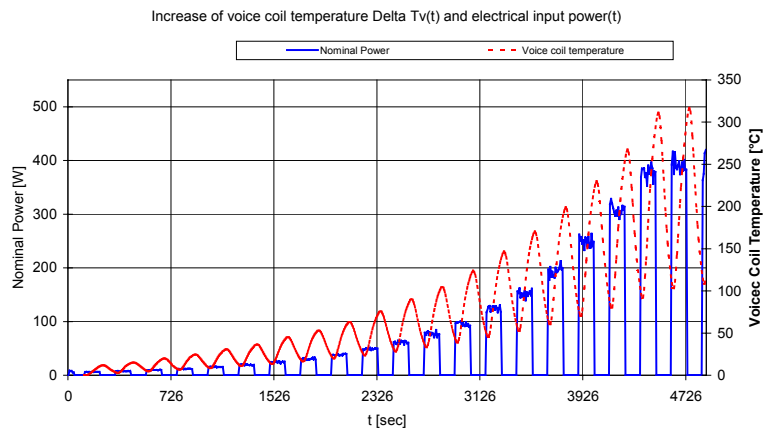

Power test done with intermittent excitation, ON interval 2min, duty cycle 50%, pink noise signal 6dB crest factor with frequency range 50-2000Hz.

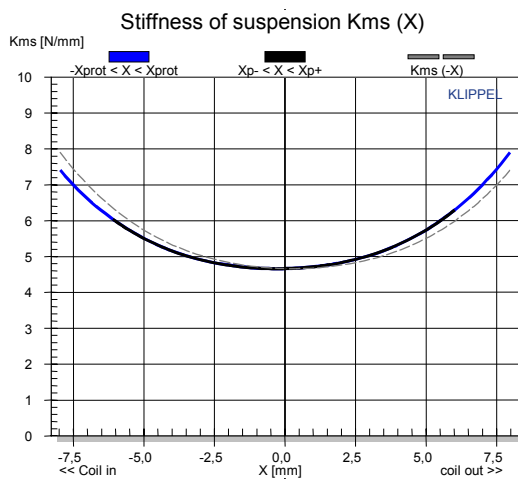

K_{ms} : stiffness of suspension variation with voice coil displacement

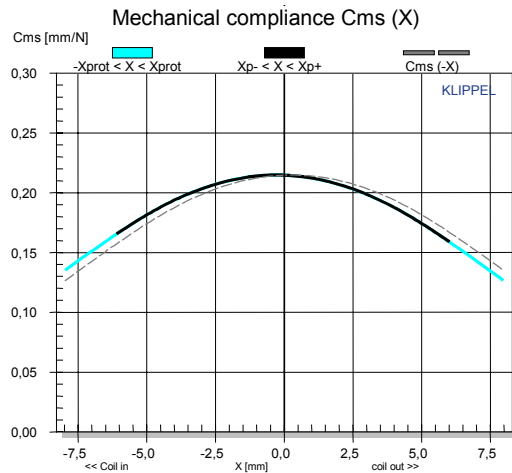

C_{ms} : mechanical compliance variation with voice coil displacement