

BRICKWALL HD NATIVE / BRICKWALL HD-DT

Mastering Brickwall Limiter Plug-In with Optional Hardware Desktop Controller

Table of Contents

Important Safety Instructions	3	7. Navigating the BRICKWALL HD Desktop Controller (optional).....	16
Legal Disclaimer	3	7.1 Features	16
Limited warranty	3	7.2 Set Gain procedure using the optional Desktop Controller.....	17
1. Introduction	4	8. Presets	18
2. Plug-in Installation.....	5	8.1 Factory Presets.....	18
2.1 Installation on a PC.....	5	8.2 User Presets	18
2.2 Installation on a Mac	5	8.3 Favorite Presets	19
3. Activate your BRICKWALL HD	6	8.4 Browse Favorites Only.....	19
iLok license	6	8.5 Make Current Preset Default	19
3.1 Activation	6	8.6 Reveal User Preset Folder in Explorer	19
3.2 Get a Free Demo License	6	8.7 Presets and the optional Desktop Controller.....	20
4. Connection and Setup	6	9. Software Updates	20
4.1 Connecting the BRICKWALL HD-DT Desktop Controller (optional)	6	9.1 Hardware Unit Software Updates (optional)	20
4.2 Operating the BRICKWALL HD.....	6	10. Specifications.....	21
4.3 How to Insert the Plug-in	7		
4.4 Mono/Stereo Operation.....	7		
4.5 Plug-in and Hardware Controls.....	7		
4.6 Connection Status to the Hardware Unit.....	7		
5. User Interface.....	8		
5.1 Bypass On/Off	9		
5.2 Main Display	9		
5.3 Meters.....	9		
5.4 Statistics	10		
6. Precision in Level and Time	10		
6.1 Two Limiter Approaches	10		
6.2 Adaptive Release Time	12		
6.3 Ceiling.....	12		
6.4 Soft Clip.....	12		
6.5 Operational Hints	13		
6.6 Modern Mastering, Loudness and True-Peaks.....	14		

EN Important Safety Instructions



Terminals marked with this symbol carry electrical current of sufficient magnitude to constitute risk of electric shock.

Use only high-quality professional speaker cables with ¼" TS or twist-locking plugs pre-installed. All other installation or modification should be performed only by qualified personnel.



This symbol, wherever it appears, alerts you to the presence of uninsulated dangerous voltage inside the enclosure - voltage that may be sufficient to constitute a risk of shock.



This symbol, wherever it appears, alerts you to important operating and maintenance instructions in the accompanying literature. Please read the manual.



Caution

To reduce the risk of electric shock, do not remove the top cover (or the rear section). No user serviceable parts inside. Refer servicing to qualified personnel.



Caution

To reduce the risk of fire or electric shock, do not expose this appliance to rain and moisture. The apparatus shall not be exposed to dripping or splashing liquids and no objects filled with liquids, such as vases, shall be placed on the apparatus.



Caution

These service instructions are for use by qualified service personnel only. To reduce the risk of electric shock do not perform any servicing other than that contained in the operation instructions. Repairs have to be performed by qualified service personnel.

1. Read these instructions.
2. Keep these instructions.
3. Heed all warnings.
4. Follow all instructions.
5. Do not use this apparatus near water.
6. Clean only with dry cloth.
7. Do not block any ventilation openings. Install in accordance with the manufacturer's instructions.
8. Do not install near any heat sources such as radiators, heat registers, stoves, or other apparatus (including amplifiers) that produce heat.

9. Do not defeat the safety purpose of the polarized or grounding-type plug. A polarized plug has two blades with one wider than the other. A grounding-type plug has two blades and a third grounding prong. The wide blade or the third prong are provided for your safety. If the provided plug does not fit into your outlet, consult an electrician for replacement of the obsolete outlet.

10. Protect the power cord from being walked on or pinched particularly at plugs, convenience receptacles, and the point where they exit from the apparatus.

11. Use only attachments/accessories specified by the manufacturer.



12. Use only with the cart, stand, tripod, bracket, or table specified by the manufacturer, or sold with the apparatus. When a cart is used, use caution when moving the cart/apparatus combination to avoid

injury from tip-over.

13. Unplug this apparatus during lightning storms or when unused for long periods of time.

14. Refer all servicing to qualified service personnel. Servicing is required when the apparatus has been damaged in any way, such as power supply cord or plug is damaged, liquid has been spilled or objects have fallen into the apparatus, the apparatus has been exposed to rain or moisture, does not operate normally, or has been dropped.

15. The apparatus shall be connected to a MAINS socket outlet with a protective earthing connection.

16. Where the MAINS plug or an appliance coupler is used as the disconnect device, the disconnect device shall remain readily operable.



17. Correct disposal of this product: This symbol indicates that this product must not be disposed of with household waste, according to the WEEE Directive (2012/19/EU) and your national law. This product

should be taken to a collection center licensed for the recycling of waste electrical and electronic equipment (EEE). The mishandling of this type of waste could have a possible negative impact on the environment and human health due to potentially hazardous substances that are generally associated with EEE. At the same time, your cooperation in the correct disposal of this product will contribute to the efficient use of natural resources. For more information about where you can take your waste equipment for recycling, please contact your local city office, or your household waste collection service.

18. Do not install in a confined space, such as a book case or similar unit.

19. Do not place naked flame sources, such as lighted candles, on the apparatus.

20. Please keep the environmental aspects of battery disposal in mind. Batteries must be disposed-of at a battery collection point.

21. This apparatus may be used in tropical and moderate climates up to 45°C.

LEGAL DISCLAIMER

Music Tribe accepts no liability for any loss which may be suffered by any person who relies either wholly or in part upon any description, photograph, or statement contained herein. Technical specifications, appearances and other information are subject to change without notice. All trademarks are the property of their respective owners. Midas, Klark Teknik, Lab Gruppen, Lake, Tannoy, Turbosound, TC Electronic, TC Helicon, Behringer, Bugera, Auratone and Coolaudio are trademarks or registered trademarks of Music Tribe Global Brands Ltd. © Music Tribe Global Brands Ltd. 2020 All rights reserved.

LIMITED WARRANTY

For the applicable warranty terms and conditions and additional information regarding Music Tribe's Limited Warranty, please see complete details online at musictribe.com/warranty.

1. Introduction

Congratulations on the purchase of your BRICKWALL HD True-Peak Limiter.

Over the past two decades, as the Loudness-Wars have raged, it has become clear that the abuse of “loudness maximizers” in mastering can significantly reduce the audio quality for the listener.

When levels get squashed against the 0 dBFS digital ceiling, then reconstructed intersample-peaks in Digital-to-Analog converters and audio file codecs (for example MP3 and AAC), may be higher than the level that consumer equipment was designed to handle. We call this level “0 dBFS+”, and often there have been no limiters in music mastering preventing such peaks from happening.

The limiters in the BRICKWALL HD are designed to:

- Continually measure if your signal contains 0 dBFS+ peaks
- Then gently remove them

The BRICKWALL HD is a transparent and upsampling True-Peak Limiter that is tightly based on the award-winning BW2 algorithm from TC’s System 6000. This is an algorithm that for the last 2 decades has proven its worth on countless high-profile records, feature-films etc.

In the BRICKWALL HD, we have:

- Refined the workflow to include modern music streaming targets
- Developed more options on Softclipping
- And not least, added a new History view that gives in-depth information and assists you in making the crucial master track decisions.

Two alternative types of Limiter are provided in one:

- The conventional Master Limiter
- The novel Loudness Limiter

The Master Limiter is a typical approach, with Input Gain to set the amount of limiting, and Ceiling to set the amount of headroom in the exported file.

The Loudness Limiter is an all-new approach, enabling a workflow suitable for modern streaming services like Spotify, Tidal, and Apple Music. Here you set a desired, resulting loudness level, which the BRICKWALL HD will automatically aim for after listening to your track.

Both Limiter types include a flexible and delicate SoftClipper that has three available options from soft, smooth, to hard.

The BRICKWALL HD’s combination of True-Peak and Loudness numerical information (STATS), provides the best possible support for making optimal decisions of dynamics, head-room and loudness level in your precious mix or master.

As a further aid, Loudness Range (LRA) and Peak-to-Loudness (PLR) read-outs provide a tangible indication of how much dynamic compression and limiting you are applying prior to, and with, the Limiter.

But remember, ultimately, your ears are the best tool you have.

For more information on Loudness, please visit:

<https://www.tcelectronic.com/brand/tcelectronic/loudness>

or visit:

<https://finalizer.com/>

For mastering in the DAW we recommend the MASTER X HD (3 band Expander, Compressor, Limiter) plug-in in combination with BRICKWALL HD. There are optimized preset “pairs” included in the plug-ins to get a head start.

For mastering in a separate and highly optimized environment we recommend the Finalizer application <https://finalizer.com/>

About this manual

Read this manual to learn how to install and use your TC Electronic BRICKWALL HD True-Peak Limiter. This manual is only available in PDF format from the TC Electronic website. To get the most from this manual, please read it from start to finish, or you may miss important information.

To download the most current version of this manual, visit the web page:

www.tcelectronic.com/Categories/c/Tcelectronic/Downloads

If you still have questions about your TC Electronic product after reading its manual, please get in touch with TC Support:

www.tcelectronic.com/brand/tcelectronic/support

2. Plug-in Installation

The combined BRICKWALL HD plug-in installer for both the NATIVE and DT Desktop Controller products can be downloaded from the following page:

www.tcelectronic.com/brickwallhd-dt/support/

The BRICKWALL HD plug-in requires an active PACE iLok license to work. See Chapter 3.

Using the Desktop Controller is optional, and all parameters are available in the plug-in.

Save the installer file (.pkg or .msi file) in a convenient location on your hard drive.

2.1 Installation on a PC

Double click the installer (.msi file). If you get a security warning, click 'Run'.



Accept the license agreement and click 'Next'.



Select which VST and/or AAX components you want to install. Pro Tools uses AAX and most other DAW programs use VST. The installer will offer a default location to save the file, but you can choose another location by clicking the 'Browse' button.

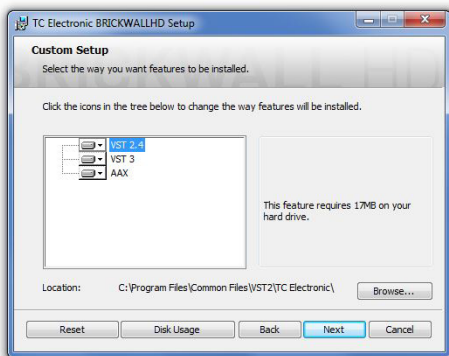

Click 'Next' to begin the installation. When installation is complete, click 'Finish'.

Note: If your DAW fails to detect the newly installed plugin, this can often be fixed by adding the following paths to the Plug-in Manager (or similar) of the DAW. The default paths on a PC are "C:\Program Files\Common Files\VST2" and "C:\Program Files\Common Files\VST3" for VST2 and VST3, respectively.

EN

2.2 Installation on a Mac

Double click the installer (.pkg) file.



Proceed through the prompts to begin installation.

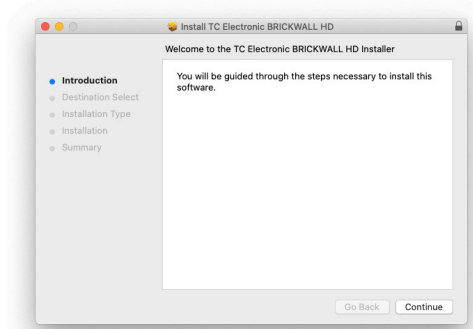

Click 'Continue.'

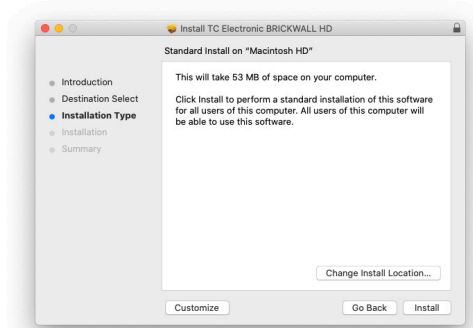

A default location will be selected for installation, or you can select another folder manually. If you have administrator authorization in place, you will need to enter your password before beginning installation.

Click 'Close' when done.

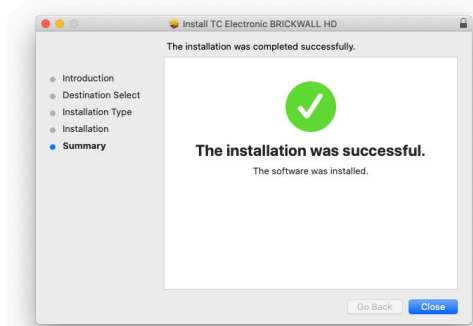

3. Activate your BRICKWALL HD iLok license

3.1 Activation

Step 1: Install iLok

The first step is to create an iLok user account at www.iLok.com and install the PACE iLok License Manager on your computer if it's your first time using iLok.

Step 2: Activation

In the received mail (when buying the NATIVE version) or on the rear cover of the printed quick start guide (when you have bought the DT Desktop Controller version) you will find your personal Activation Code. To activate your software, please use the "Redeem an Activation Code" feature in the PACE iLok License Manager.



3.2 Get a Free Demo License

Make use of this hassle-free offer to try out our plug-ins before you buy.

- 14-Day Trial Period
- Fully Functional
- No Feature Limitations
- No Physical iLok Key Needed

Step 1: Install iLok

The first step is to create a free iLok user account at www.iLok.com and install the PACE iLok License Manager on your computer if it is your first time using iLok.

Step 2: Get your free license

Go to www.tcelectronic.com/brand/tcelectronic/free-trial-brickwallhd-native and enter your iLok User ID.

Step 3: Activation

Activate your software in the PACE iLok License Manager.

4. Connection and Setup

4.1 Connecting the BRICKWALL HD-DT Desktop Controller (optional)

Getting the Desktop Controller up and running couldn't get any easier. Plug the included USB cable into the unit's rear micro-USB port, and connect the other end to a free USB port on your computer. The Desktop Controller is bus powered, so no other power cables are necessary, and no additional drivers need to be manually installed.

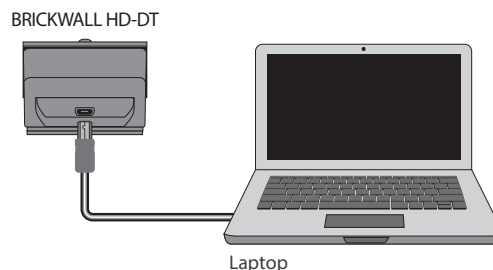

The Desktop Controller will light up upon successful connection. You can now apply the plug-in to a channel in your DAW to begin using the effect. This process may vary slightly depending on your software, but generally should require these steps:

- Select a channel or bus in your DAW to which you would like to add the effect. Access the mixer page where you should see a section dedicated to effect slots
- Open the menu where you can select from a list of effect types, which probably includes many stock plugins that are included with the DAW. There should be submenu to view general VST/AU/AAX options.
- The plug-in will likely be found in a dedicated TC Electronic folder. Select the BRICKWALL HD and it will now be added to the signal chain.

Double click on the effect slot that contains the BRICKWALL HD to view the plug-in UI. There should be a green link icon at the bottom, and text that indicates successful connection between the plug-in and the Desktop Controller.

4.2 Operating the BRICKWALL HD

After you have installed the plug-in, activated the iLok license, and optionally connected the BRICKWALL HD-DT Desktop Controller via USB, you can begin inserting the plug-in to your tracks.

Adjustments to the effect are done in two ways: either by using the plug-in user interface, or optionally via the physical Desktop Controller.

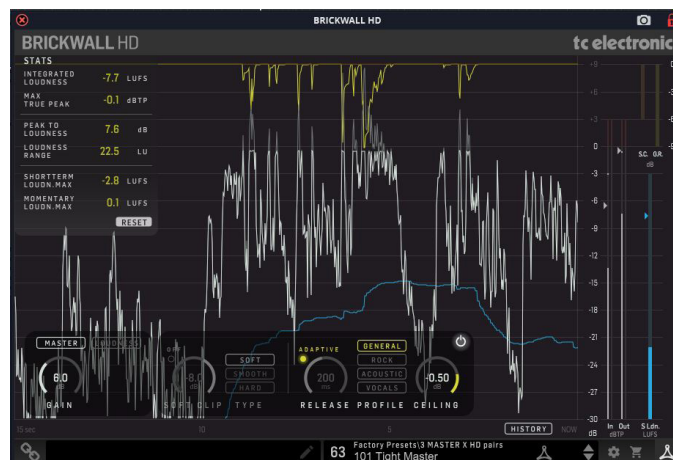

4.3 How to Insert the Plug-in

The BRICKWALL HD is intended for insertion directly into an effect slot on the DAW master bus as the last plug-in, with the aim of handling the final and very delicate process before bouncing your audio project, or recording the output back to a final master channel. But it can also be used on a sub mix bus with great success, or on a single instrument channel where limiting may be needed for more artistic reasons.

4.4 Mono/Stereo Operation

The BRICKWALL HD is intended for stereo use, but can also be used both as a mono instance on mono tracks.

In the case of a mono-out instance, the output signal is made by outputting the left plug-in channel only.

4.5 Plug-in and Hardware Controls

After you have installed the plug-in, activated the iLok license, and optionally connected the BRICKWALL HD DT desktop controller hardware unit via USB, you can begin using it.

The controls of the plug-in and desktop controller are described in more detail later in this manual.

Plug-in User Interface:

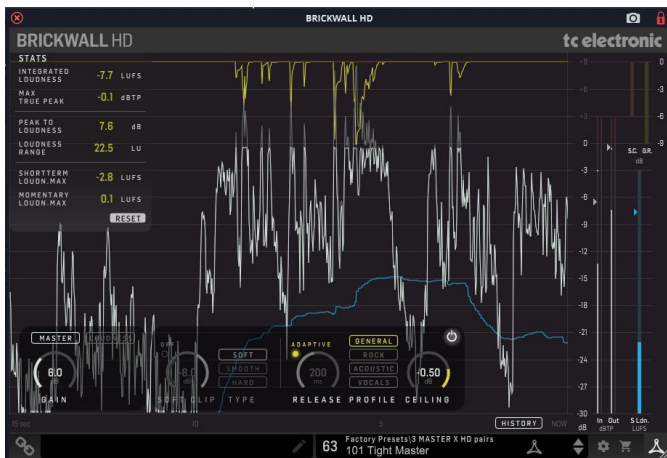

The Optional Desktop Controller Hardware Unit:

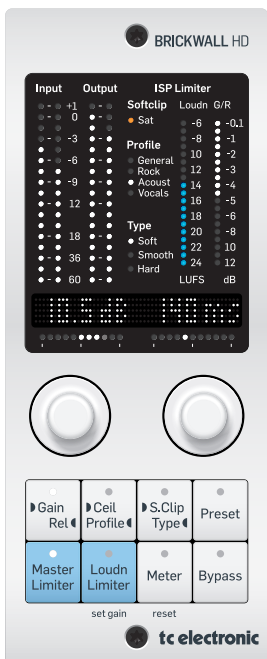

4.6 Connection Status to the Hardware Unit

The TC Icon family all use the same method to show the connection status between the plug-in and the hardware unit.

Connection status is indicated on the lower left side of the plug-in window. Successful connection is indicated with a green chain icon. The Tooltips area will show the plug-in instance name that the hardware unit is currently connected to. This is often the DAW channel name. If your DAW does not support this, you may enter a name for the instance. This may be especially convenient when using DAW project templates.



When using the NATIVE version only, this chain icon will remain grey:



If another instance of the plug-in already exists on another track, the chain icon will appear yellow, and the text box will notify you where the plug-in is currently active. Click the chain icon to connect the hardware unit to the new plug-in location.



To summarize the connection status possibilities:

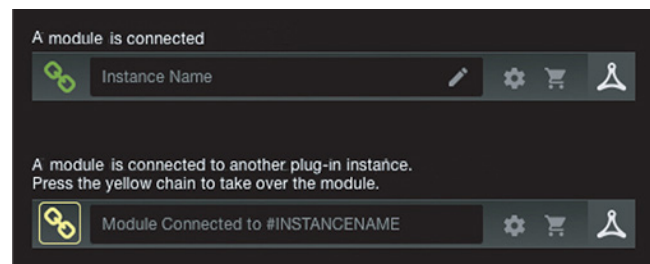

Most DAWs offer the ability to move or drag plug-ins from one track/bus to another, and BRICKWALL HD supports this as well.

Most DAWs also feature an on/off switch for plug-ins, accessible inside the plug-in window and/or the track itself. Muting the plug-in will make the effect inaudible, but will not shut down the connection to the hardware unit.

5. User Interface

Control of the BRICKWALL HD is done in the plug-in, or using the optional hardware unit (when you have purchased the DT version).

Limiter Parameters:

- Limiter Gain (Master Limiter): 0.0 to +18.0 dB
- Output Target Loudness (Loudness Limiter): -25.0 to -6.0 LUFS
- Use the Set Gain button to automatically optimise for Spotify/Apple/AES Stream platforms
- Level Ceiling: -6.0 to 0.0 dBTP
- Adaptive Release: On/Off. Because dynamic release times are included with the Adaptive profiles, Release becomes inactive when Adaptive is selected
- Release time: 20 ms to 3.0 sec (applies when Adaptive Release is Off)
- Limiter Profile: General, Rock, Acoustic, Vocals (applies when Adaptive Release is On)

Softclipper:

- On/Off, a convenient way of A/B'ing the settings.
- Type: Soft, Smooth, Hard
- Threshold: 0.0 to -20.0 dBFS

Meters:

- Limiter Input/Output, with indication of Threshold and Ceiling
- Soft Clip Gain Reduction
- Limiter Gain Reduction
- Short-Term Loudness, with Integrated Loudness indication

Main Display (shown when History is on):

- 15 second scrolling view of levels and gain reduction
- Limiter Input, shown after applied Gain, is grey
- Limiter Output is white
- Soft Clip Gain Reduction is orange
- Limiter Gain Reduction is yellow
- Short-Term Loudness is blue

Stats View:

- These are the measurements since the last plug-in insert, last Reset or the DAW project load. Press Reset to clear the measurements
- Integrated Loudness
- Max True-Peak
- Peak-to-Loudness
- Loudness Range
- Short term Loudness Max
- Momentary Loudness Max

At the bottom left:

- Connection status "Chain" icon
- Connection status message and Tool Tips

At the bottom right:

- Preset number, preset name, factory or user, favorite, preset up/down
- Setup
- Shopping cart
- User Interface size adjustment

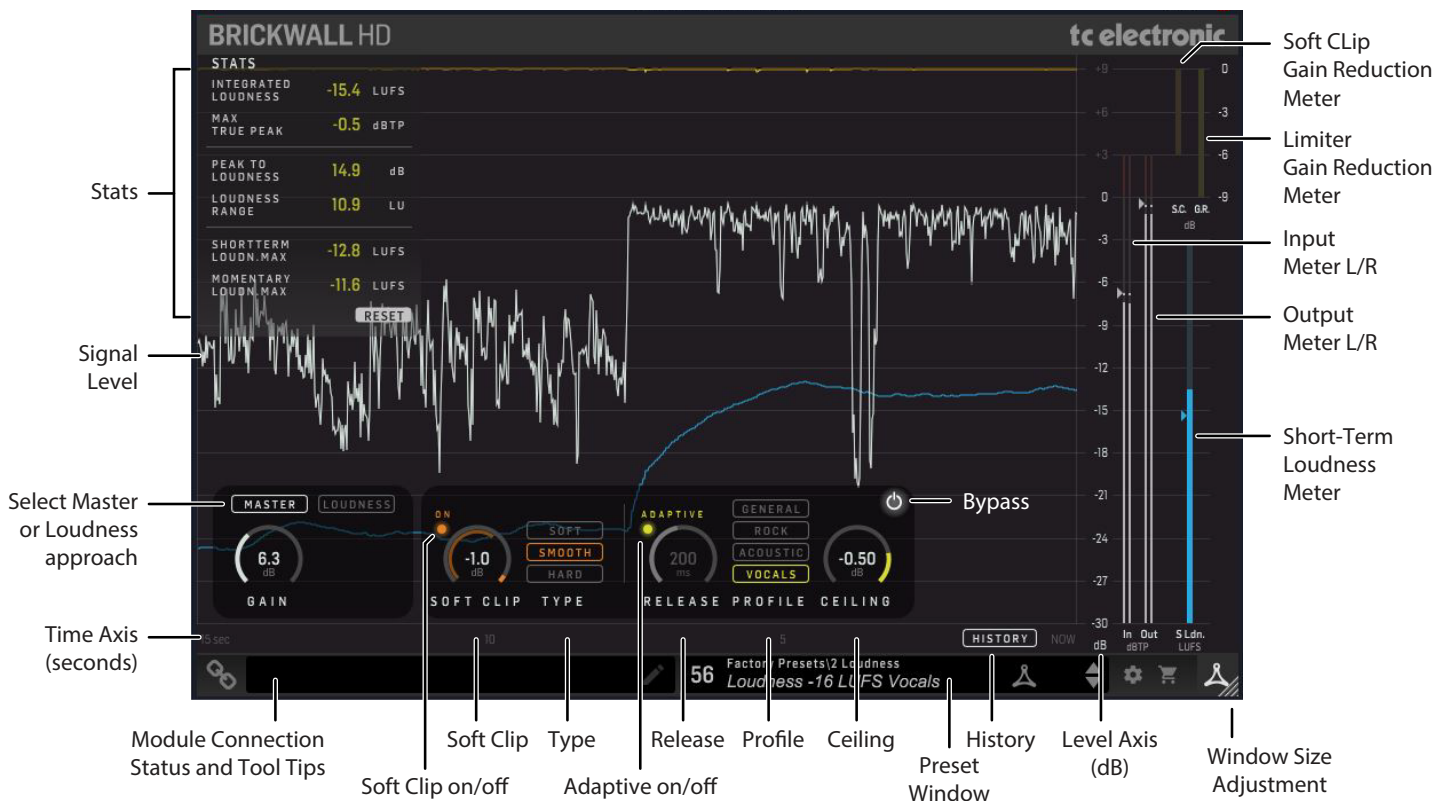

The controls and features are described in more detail below:

5.1 Bypass On/Off

Press this very important button to bypass or engage the BRICKWALL HD. This makes it easy for you to listen and compare the overall effect of your work.



5.2 Main Display

When the HISTORY button is engaged, the display will show the currently-playing program levels and gain reduction varying with time. The meters at the right show the level and gain reduction at the DAW playhead position (the "Now").

When HISTORY is off, the scrolling display is not shown, and the information at the DAW playhead position is shown in the meters.

- This display has a linear vertical dB scale and a horizontal time scale
- The display is a 15 second scrolling view, with "Now" at the right, and -15 seconds at the left. It can be restarted by pressing the RESET button in the STATS menu at top left
- Limiter Input/Output (-30 to +9 dBTP)
- Input Level, before the Gain has been applied, is shown in grey
- Output Level is shown in white
- Soft Clip Gain Reduction (-39 to 0 dB). Soft Clip is orange
- Limiter Gain Reduction (-39 to 0 dB). Limiter is yellow
- Short-Term (3 sec) Loudness (-30 to -3 LUFS). Loudness is blue

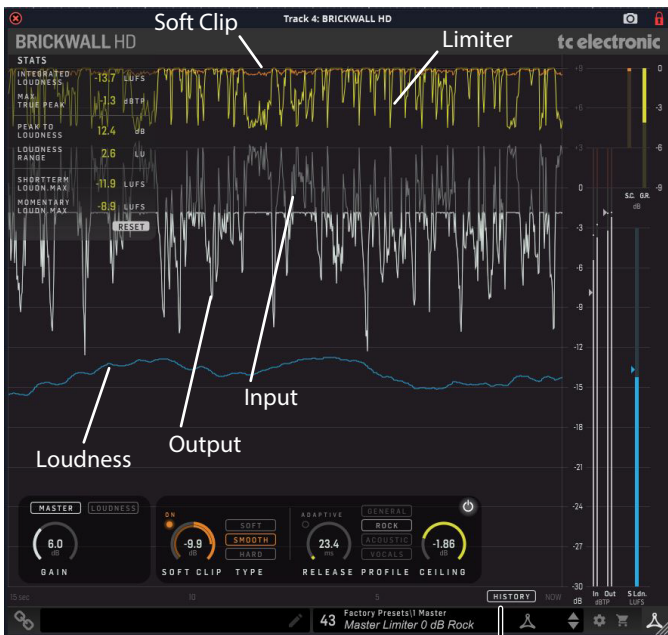

5.3 Meters

The meters at the far right indicate the levels and gain reduction at the DAW playhead (Now) position. (If the History switch is engaged, then the scrolling graphs show the meter readings vs time.)

- Use the Master Gain control in the controls area to adjust the input level if required
- Limiter Input/Output (-30 to +3 dBTP, with indication of Threshold and Ceiling)
- Input Level, before the Gain has been applied, is shown in grey
- Output Level is shown in white
- Soft Clip Gain Reduction (-6 to 0 dB) in orange
- Limiter Gain Reduction (-9 to 0 dB) in yellow
- Short-Term (3 sec) Loudness (-30 to -3 LUFS) and Integrated Loudness indication, in blue
- When in the Master Limiter mode, the small triangle on the input meter represents the Limiter threshold, and is the opposite of the Master Limiter gain. For example, if Gain = 5dB, then Threshold = -5dB
- When in the Loudness Limiter mode, the triangle on the input meter is again the Limiter threshold, but how it is set is determined after the Set Gain procedure.
- The triangle on the output meter represent the Ceiling setting

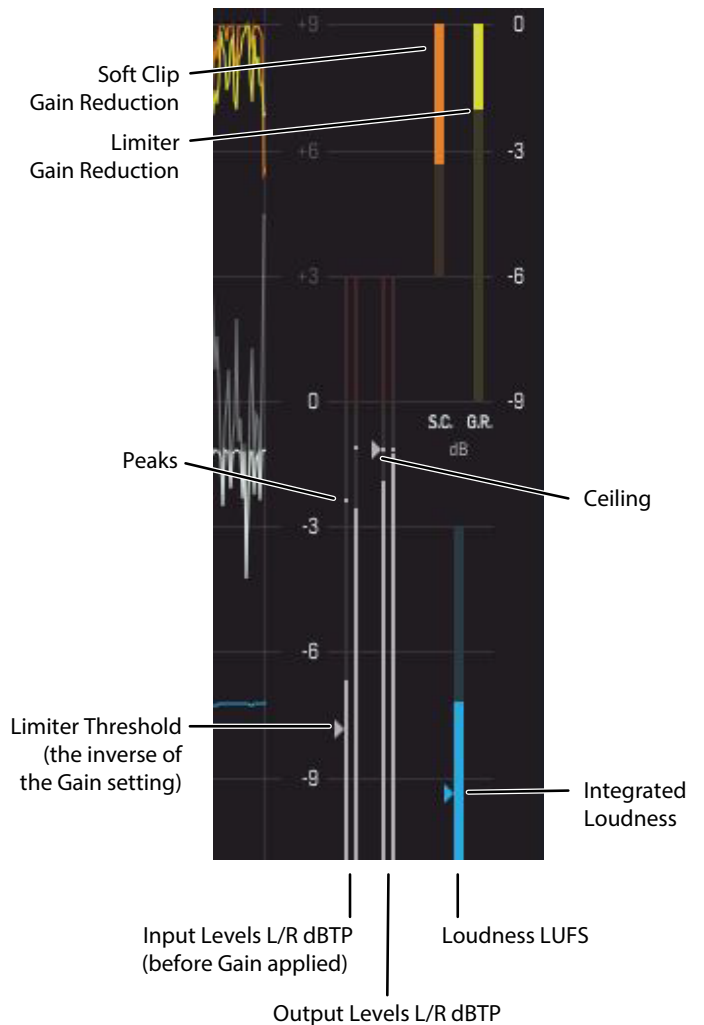

5.4 Statistics

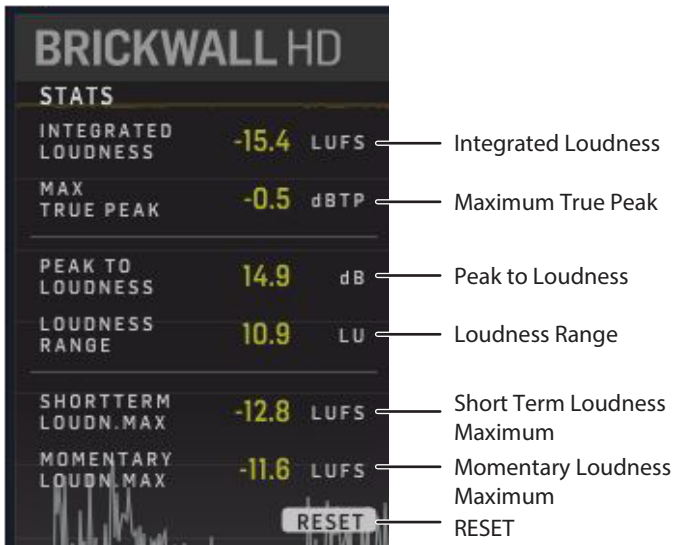

Stats View:

- These are the measurements since the last plug-in insert, last Reset or the DAW project load. Press Reset to clear the measurements
- Integrated Loudness (I), LUFS. This is the measured Integrated Loudness since the last Reset
- Max True-Peak, dB True-Peak. This is the measured maximum True-Peak level
- Peak-to-Loudness (PLR), dB. This is the distance from the measured maximum True-Peak level to the Integrated Loudness
- Loudness Range (LRA), LU. This is the Loudness Range
- Short term Loudness Max (3 sec), LUFS. This is the measured maximum short term Loudness level
- Momentary Loudness Max (400 ms), LUFS. This is the measured maximum Momentary Loudness level
- Note: Bypassing the BRICKWALL HD, or cycling or moving the DAW playhead will make the Stats invalid for your track. Press Reset and play the part (maybe all) of the track you want to be measured in one continuous go

6. Precision in Level and Time

In music track mastering, it is common practice to allow level to digital Full Scale on a sample by sample basis. This has the consequence that down-stream elements such as audio file codecs like MP3 and AAC or play back systems like CD players will behave unpredictably, and in many cases add distortion you don't hear in the studio. The distortion is not harmonic, can be quite severe (more than 10 %) and cause early listening fatigue.

The key to remove this problem that we call 0 dBFS+ peaks, is to use a True-Peak Limiter like BRICKWALL HD. The threshold can now be set safely at 0.0 dBFS, while BRICKWALL HD still takes care of peaks that would otherwise cause distortion.

The BRICKWALL HD limiter operates with highly-extended precision in both level (True Infinite headroom) and time (5 times oversampling). Its processing engine, PPM level meters, History and Stats are all upsampled in order to identify intersample and 0 dBFS+ peaks in the precious Mix or Master track. Therefore, the meter scales are extended to +3 dBFS because excessive level normally falls between 0 and +3 dBFS, and most consumer equipment already exhibits distortion at +0.5 dBFS.

6.1 Two Limiter Approaches

The two alternative types of Limiter are provided in BRICKWALL HD: The conventional Master Limiter, and the new Loudness Limiter.

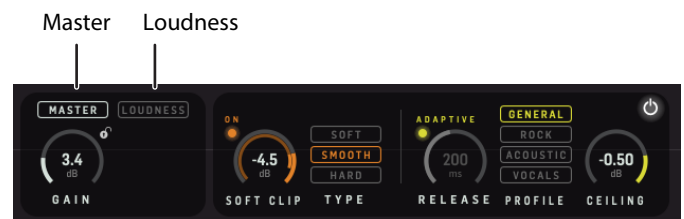

- The Master Limiter is a typical approach with input gain to set the amount of limiting, and Ceiling to set the amount of headroom in the exported file.
- The Loudness Limiter is an all-new approach, enabling a workflow suitable for modern streaming services like Spotify, Tidal, and Apple Music. Here you set a desired, resulting, loudness level, which the BRICKWALL HD, after listening to your track, will automatically aim for by setting the Gain under the hood.

For both types, when the input level exceeds the Threshold, the signal will be attenuated and the Gain Reduction meters at upper right of the main view and the History curves will display the max amount of reduction applied to either of the audio channels.

6.1.1 Master Limiter



The overall Gain control sits at the input of the limiter. Adjust it to hit the True-Peak and Loudness level that you aim for. When input peaks hit the Limiter threshold at 0 dBFS, the limiter will kick-in to ensure that no peaks will exceed 0 dBFS True-Peak at the Limiter output.

Adjust the Ceiling to add margin relative to 0 dBFS.

The resulting Integrated Loudness that defines how loud the track is perceived is shown as the blue Triangle in the right side of the main view. A set of descriptors are collected in the STATS view. Press Reset to make a new measurement.

The small "lock" next to the control allows you to keep the value when a new preset is selected.

Adjust the gain either by dragging over the control, or clicking on the number and entering the numeric value.

6.1.2 Loudness Limiter

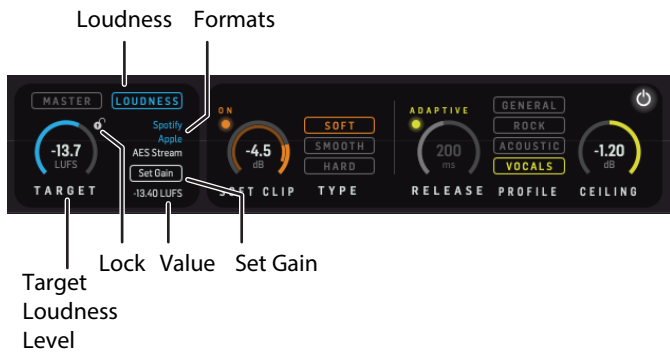

Choose the Loudness Limiter for a fast workflow if you know what Loudness level you are aiming for.

The small "lock" next to the control allows you to keep the value when a new preset is selected.

Adjust the loudness level either by dragging over the control, or clicking on the number and entering the numeric value.

1. Set the Target Loudness level, to -15 LUFS for example.
2. The Spotify/Apples/AES Stream texts will individually light up if your Loudness target is appropriate for these platforms.

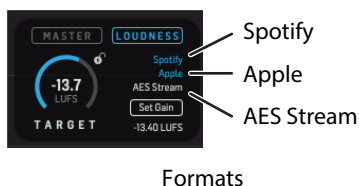

Note that these recommendations are bound to change now and then. To see latest evolution, please refer to <https://finalizer.com/analyzer>

3. Start DAW playback of your project or track, and press Set Gain to let BRICKWALL HD listen to the content. The Set Gain button will read "Listening".

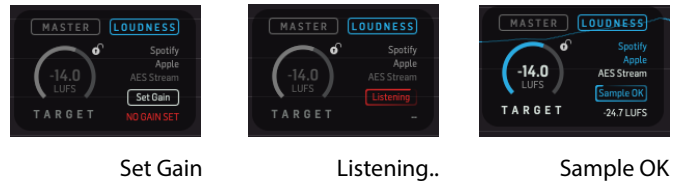

4. When the Loudness measurement on the Limiter input (below the Set Gain button) is not evolving anymore or when the button reads "Sample OK" you may press the button to stop listening. During Listening, all measurements including STATS and History in the plug-in view are based on the input signal.
5. Now, the measured input loudness and the adjusted Target Loudness are used to set the Gain behind the scenes, which will result in the Limiter working to aim for the Target Loudness.
6. The Input Loudness Level may also be entered with your keyboard, by first clicking on the value below the "Set Gain" button. This may be convenient if you already have an Integrated Loudness result obtained using another tool.

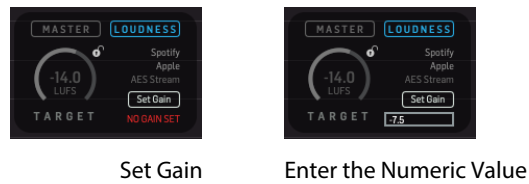

A few things to note

- It is recommended that you let the BRICKWALL HD listen to multiple passages in your track, especially the loudest, to help BRICKWALL HD hit the target optimally.
- BRICKWALL HD will show different messages if the Set Gain-feature is not able to find appropriate settings due to the sample being: Too short, too low audio level, no audio detected etc.

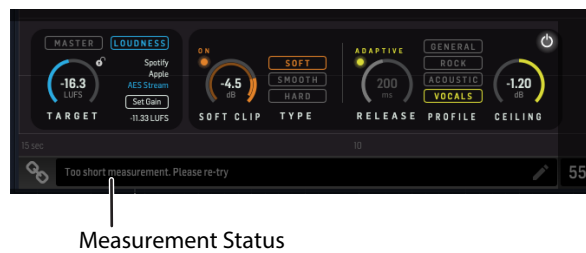

More information:

Free online analyzer for comparing your own music to well-known, professionally mastered tracks <https://finalizer.com/analyzer>

Loudness <https://www.tcelectronic.com/brand/tcelectronic/loudness>

TC Electronic papers on 0dBFS+ and True-Peak <https://www.tcelectronic.com/brand/tcelectronic/tech-library/mastering>

In-app mastering: <https://finalizer.com/>

6.2 Adaptive Release Time

Many different objectives exist when it comes to peak-limiting audio. From taking care of a few peaks in a gentle way, to significantly pushing up the average/peak ratio in order to raise the apparent loudness, for voice cut-through, or a dozen other reasons. BRICKWALL HD extends the adaptive release time control of earlier incarnations to include numerous new internal variables, to make the algorithm respond intelligently for a number of applications.

Click the Adaptive LED to enable Adaptive Release Time and take advantage of the different Profiles.

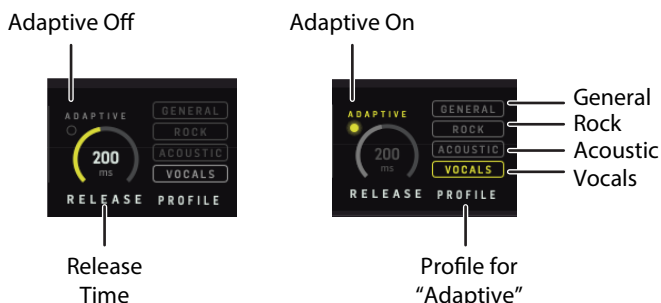

6.2.1 Profile

The adaptive Profiles allow you to tell BRICKWALL HD what your intentions are. The selected Profile is only active when Adaptive is enabled.

Several internal variables are dynamically updated based on the Profile chosen, so distortion is perceived (and measured) to be as low as possible for a given loudness, and reduction in average/peak ratio. Maximum perceived distortion tolerated is different from Profile to Profile. The multi-dimensional parameter-space is fully continuous to avoid situations where distortion could occur.

- The General Profile has a higher tolerance for perceived distortion than Acoustic. It is still magnitudes better than analog designs, but may be on the aggressive side for sensitive music. It is a good choice for many types of music, and in live production where you don't know what to expect.
- The Rock Profile again has a higher tolerance for perceived distortion, and is therefore better suited for typical Rock/Electric mix and mastering projects, rather than live applications.
- The Acoustic Profile offers gentle processing with minimum static and dynamic distortion. It's a first choice for audiophile limiting, for instance with classical music, choir etc.
- The Vocals Profile is targeted human voice, and adapts well to asymmetrical signals. Used on composite material, perceivable distortion is to be expected with large ratios of limiting.

6.3 Ceiling

The Ceiling is intended for reserving headroom in your master file against 0 dBFS True Peak. Often, downstream processors like Digital-to-Analog converters in consumer playback systems or lossy audio file Codecs like MP3 and AAC used in Streaming Services are not safely handling peaks that cross 0 dBFS and this may result in unpredictable distortion, even if the master file sounds perfect in the studio. To ensure extra margin against this problem Ceiling can be left a bit lower than 0 dBFS, say at -0.5 dBFS.

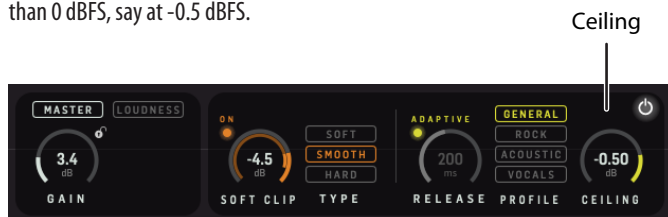

6.4 Soft Clip

Soft Clip is a bandwidth-limited distortion effect, not unlike analog tape saturation. Soft Clipping can assist the Limiter in increasing loudness for a signal at the price of distortion. While the Limiter has a release time, the Soft Clipper acts instantly to transients so their audible artefacts are different.

When the Limiter and Soft Clipper are used in combination, it is possible to relieve the dynamic Limiter by applying the Soft Clipper. When used in combination with the dynamic Limiter, Soft Clip can produce a louder and denser impression than the dynamic limiter by itself.

Note: If misused, excessive Soft Clip may lead to an ear-fatiguing sound.



6.4.1 Soft Clip Threshold

The Soft Clipper sits on the plug-in input before the gain applied by the Limiter. Therefore the Soft Clip threshold setting relates to the plug-in input level shown on the Input PPM meter.

Adjust the Threshold by dragging the control or by clicking and entering the value.

Note: The Threshold can be easily set by viewing the inner-ring level meter inside the Threshold parameter outer-ring. A highlighted overlap between the signal level and threshold rings will indicate that the Soft Clipper is in action and limiting the signal.

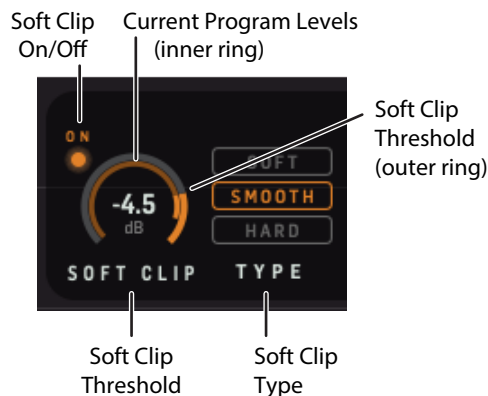

6.4.2 Soft Clip Type

The BRICKWALL HD includes newly-refined and developed options for Soft Clipping.

There are three Types to choose from, and they all represent variations on the soft clipping theme. Which of them is preferred on the specific content with the chosen threshold, and possibly in combination with the Limiter, can only be judged by listening in the given situation.

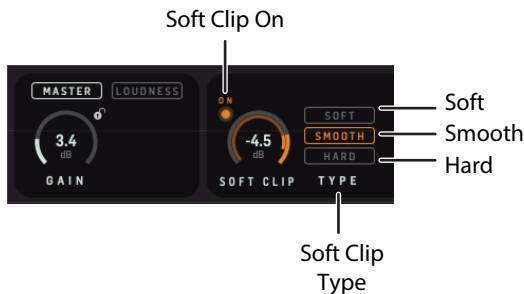

- Soft is a 9 dB “knee” soft clipper
- Smooth is a continuous “knee” from very low levels all the way to the top. The curve is optimized for least perceptual distortion.
- Hard is a 2 dB “knee” soft clipper

Note: Use the Soft Clip On/Off as a convenient way of A/B'ing the settings.

Note: To avoid nasty surprises, such as an unexpected high amount of clipping in the last chorus – because it happened to be a little louder – make sure to check the Soft Clip threshold setting at the loudest passages in your track.

Note: When processing sensitive material, and for live applications, it is recommended to turn off Soft Clip to avoid bad surprises.

6.5 Operational Hints

Master Limiter: Normal operating procedures involve first setting the Limiter Gain in order to reach the desired Output level.



Loudness Limiter: Set the output Loudness Level, activate Set Gain while playing back your track and let the BRICKWALL HD automatically set the limiter threshold. Click the Set Gain button again to stop measuring when it has measured long enough – observe when the measured loudness value below the Set Gain button has found its level.



Use the Gain Reduction meters, the History readings, the STATS, and your ears, as guidelines to when it is time to stop adding more Limiter Gain, or if the Output Loudness level is maybe set too high. For not-previously limited or -compressed signals, as a rule of thumb, be very careful if exceeding 8 dB of total gain reduction, if not for artistic reasons. If the signal is already dynamic range compressed, less drastic limiting treatment should be used.

We recommend fine-tuning the limiter parameters, in combination with parameters of any dynamic compressor earlier in the processing chain. Experiment with different Limiter Release times, or use the highly intelligent Adaptive Limiter Profiles relative to your music style, and, if needed in order to relieve the Limiter a bit, add Soft Clip and find the type and amount that best compliments the material.

6.5.1 How to read the History

The all-new scrolling History view gives in-depth information and assists you in making the crucial mix or master track decisions. While we fully support that your ears is the most important tool, you may find it useful in the delicate final adjustment process to see a scrolling view of the audio transients as well as the gain reductions for both the Limiter and the Soft Clipper.

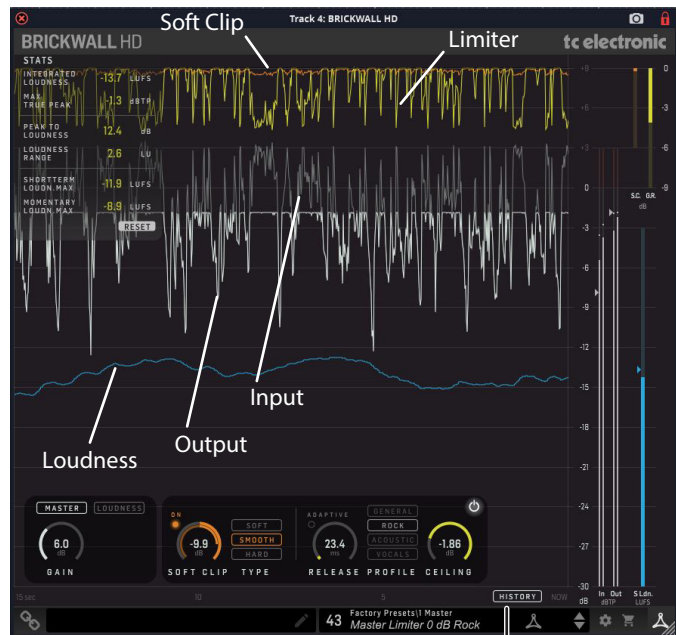

It is possible to see the following:

History

- The release time of the limiter, and see how it may end up nearly as a general level reduction of your mix if the Release Time is too long
- How the different Limiter Profiles behave on your mix, especially if you cycle a small part of your mix while looking carefully at the Limiter Gain Reduction curve
- How the Soft Clipper is an instant gain reduction, compared to the Limiter, which has a dynamic behavior. This can be seen both on the Gain Reduction curves, as well as on the difference between the Input signal (grey curve) and the Output signal (white curve)
- How the Ceiling parameter sets the margin from 0 dBFS to the max True-Peaks of your mix
- The relation between the transients and the short term (3 sec) Loudness curve. The Loudness curve will display how your mix progresses loudness-wise, for example from verse to chorus, or from first to last chorus. This will help you decide if it has the amount of impact you are aiming for. In this process, it may also help suggesting changes in the upstream-process such as the actual mix or potential master bus compressor settings
- Note: It may be useful to use reference audio tracks when making decisions on your mix
- You may also refer to our free online analyzer for comparing your own music to well-known, professionally mastered tracks: <https://finalizer.com/analyzer>

6.6 Modern Mastering, Loudness and True-Peaks

The BRICKWALL HD is highly suitable for the mastering process, with many ways to make your mix sound better, but if not used wisely, there are many ways of making it sound worse!

There is a risk of becoming speed-blind in the tuning process, and at first prefer an over-compressed and loud-sounding track. This is a situation that can be avoided by:

- Knowing your music genre deeply
- Using relevant reference tracks for comparison
- Ensuring calibrated monitoring levels
- Using an optimized monitoring environment

The resulting Loudness and Dynamic Compression are two of the most important properties of a track, adjusted finally in mastering. These two properties can be regarded as counterparts to each other. In other words, it is important to:

- Decide how loud your tracks should be
- Design the dynamic profile of your music

Due to the fixed 0 dBFS ceiling, louder tracks have less dynamics, and “weaker” tracks will potentially have more dynamics.

We recommend that you do not hyper-compress and limit your tracks to the extreme in the mastering process, in order to achieve a loud track. If you overdo it, it will reduce the audio quality of your work. And often, there is even a penalty in playback stages so your loud track may end up sounding weaker, rather than louder.

6.6.1 Loudness

The Loudness approach to music mastering is based upon similar methods introduced more than a decade ago by the industry producing audio for TV.

Loudness measures how loud we actually hear audio, which is different from “level” PPM meters that look at transients only. The Loudness method includes K-filtering that emulates human hearing, where bass affects the perceived loudness level less, and where frequencies from approximately 2 kHz and up affect the perceived loudness level more.

Loudness is a modern, but still well-rehearsed reference method, which is standardized in BS-1770, and many music streaming services refer to this standard, or similar proprietary methods.

Loudness is measured on the LUFS metering scale. LUFS stands for “Loudness Units Full Scale.” The scale does not measure sound as a dB meter or a VU meter would. Rather, it accounts for how the human ear (and brain) perceives the loudness of a track. That is also why there is only one loudness value or level, instead of one per channel.

Loudness examples: Some Streaming Services will aim for -16 LUFS loudness when they play back music tracks with “Sound Check” enabled. The AES community recommend streaming music between -20 and -16 LUFS. Often you will see songs that measure -14, -12, -10 or even -8 LUFS and it will vary for example by music genre.

6.6.2 True Peak

Often, there can be small peaks of sound in-between digital samples, inter-sample peaks, that go undetected in digital tools including our MASTER X HD. Where traditional peak meters and conventional peak limiters fail to read those true peaks of sound, a True Peak meter will provide the mastering engineer with the actual reading.

Without a True Peak meter and True-Peak Limiter especially, a mastered track could go into digital clipping when converted to a lossy format like MP3 or AAC or when being Digital-to-Analog converted in normal playback systems. This can happen, even if no distortion is heard when monitoring the final master.

For a modern, versatile and trustworthy mastering chain, we recommend the BRICKWALL HD True-Peak Limiter is inserted after the MASTER X HD to ensure elimination of the potential and problematic inter-sample peaks in your final master track.

6.6.3 Beware of The Loudness Wars

An important note on loudness, is that there has been a trend in mastering toward making songs appear louder and louder. Since you can never exceed the 0dBFS digital ceiling, applying a brickwall Limiter at the final stage, the result often has been to apply very aggressive settings on dynamics tools such as multiband compressors, so-called ‘loudness optimizers’, as well as the final Brickwall Limiter itself. This phenomenon has been referred to as ‘The Loudness Wars’.

This escalated because we naturally perceive a louder version of a song to be better than a softer version, when you compare them directly. Another cause is that record industry people would compare an ‘airplay’ version of one track to a newly mastered CD track, where the former tended to sound louder and fatter due to FM broadcast processing – leading to a request to make the master louder, with more cowbell. Well, the ‘wars’ may have peaked, but it is still something that you should be aware of and pay attention to. And while we say that they may have peaked, they are not completely over. . .

Further, if you apply extreme amounts of compression, distortion occurs, which may lead to listening fatigue for you as well as your audience. Of course, the amount of compression that you can use in order to fit a certain music genre can vary, but just stay aware of how it affects your music, and act accordingly.

It is also very important that you always listen to your own mastering project and your reference library at the same loudness level when you compare them. There is no doubt that while a heavily compressed song – dynamically speaking – may sound more impactful at first, you will sacrifice detail and nuance.

Finally and as mentioned above, keep in mind that the current trend in music streaming is a target loudness of approximately -16 LUFS, so if you deliver a significantly louder song, it will get turned down automatically if the listener chooses to apply the ‘normalization’ feature such as ‘SoundCheck’ or ‘Same Level’ that aligns the loudness of the songs in the library. And if that happens, your very loud song may well end up sounding much less impressive than the competition!

6.6.4 Compress-O-Meter - Master Analyser

TC Electronic has launched a free on-line service at the following address:

<https://finalizer.com/analyzer>

This analyzer can help you investigate and decide the suitable loudness level and amount of dynamics processing for your music, when you compare it to your preferred reference tracks, or pre-analyzed giant hits through the history.

A central part of this service is the Compress-O-Meter:

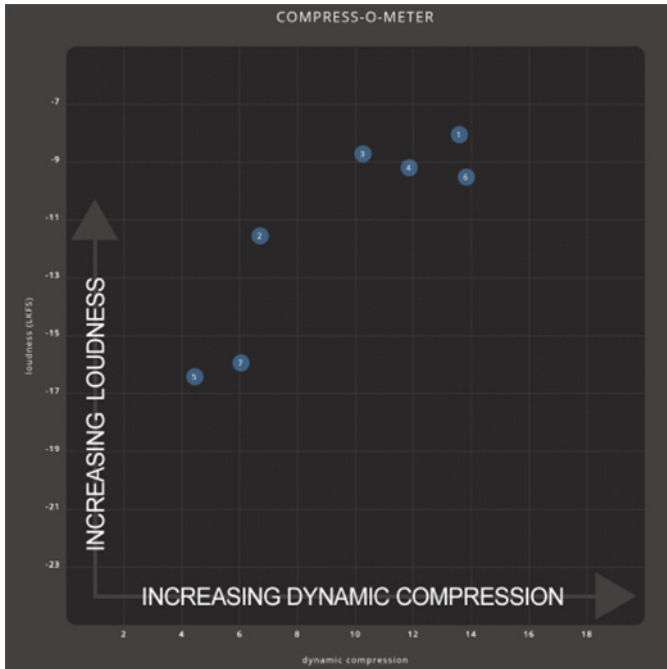

The X-axis is the amount of Dynamic Compression. It is unit-less, so you should not add "dB", "ratio", or similar, when thinking about it.

The Dynamic Compression is based on the track's Peak-to-Loudness (PLR) value and a measurement of the micro-dynamics of the track.

- Very dynamic music with lots of transients and loud and soft passages, will have a low Dynamic Compression value, to the left in the Compress-O-Meter.
- Very dense music with little transients, will have a high Dynamic Compression value and show up to the right.

The Y-axis is the full track Loudness value, shown in LUFS (Loudness Units Full Scale).

6.6.5 Modern Mastering

Another highly relevant combination of processing can be carried out with MASTER X HD and the TC Electronic BRICKWALL HD limiter in series as the last step before bouncing your mix or master.

The MASTER X HD will add 3-Band Expansion, Compression and Limiting, and it is able to act both as downward and upward compressor, so it is a strong companion to the BRICKWALL HD.

There are suitable presets "pairs" located in the Preset menus of the two plug-ins as an aid to using the two plug-ins together.

EN 7. Navigating the BRICKWALL HD Desktop Controller (optional)

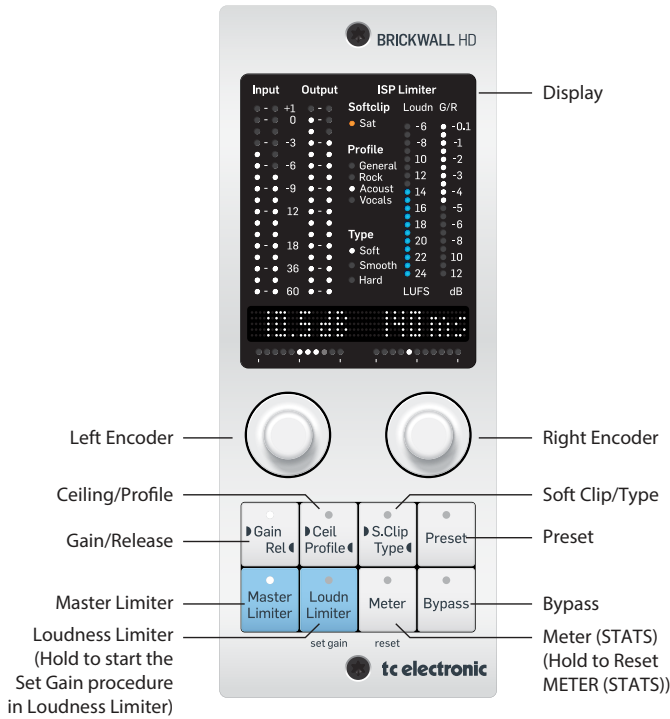

7.1 Features

7.1.1 Display

The desktop controller display shows the following details:

- Input Level L/R, PPM, True-Peak, dBFS
- Output Level L/R, PPM, True-Peak, dBFS
- Soft Clip Saturation, glowing LED with amount of gain reduction made by the Soft-Clipper.
- The chosen Limiter Profile: General, Rock, Acoustic, Vocals
- The chosen Soft Clip Type: Soft, Smooth, Hard
- Loudness bar showing short term (3 sec) loudness
- Limiter Gain Reduction

7.1.2 Master Limiter and Loudness Limiter

Select between the Master Limiter approach and the Loudness Limiter approach. The LED on the selected Limiter Type will light up.

7.1.3 Meter

Selecting the Meter button will reveal a pair of the STATS in the text display. Use the encoders to select which pair to see in the display.

The first time you select a pair, their names are shown, followed by the units. The next time you press Meter, only the values will be displayed. Press Meter again for a reminder of what descriptor pair and units are currently shown.

The pairs are:

- Integrated Loudness (I) LUFS, and Max True-Peak dBTP
- Peak-to-Loudness (PLR) dB, and Loudness Range (LRA) LU
- Short term Loudness Max (3 sec) LUFS, and Momentary Loudness Max (400 ms) LUFS
- PPM Peak Hold for left and right channel, dBFS True-Peak

Holding the Meter button will reset the STATS. The STATS are measured after the plug-in is inserted, after the last Reset, or the DAW project load. You can also press Reset on the plug-in GUI to clear the measurements.

7.1.4 Bypass

Select bypass to quickly bypass the BRICKWALL. This will help you to judge the effect of the plug-in on your sound.

7.1.5 Gain/Release

Selecting the Gain/Rel button will assign Limiter Gain (Master Limiter) or Target Loudness (Loudness Limiter) to the left encoder, and the Limiter Release to the right encoder.

The value for each parameter will be shown in the display above, and the horizontal LED bar will show the value setting in the value range, similar to the circles in the plugin.

7.1.6 Ceiling/Profile

Selecting the Ceiling/Profile button will assign the Limiter Ceiling to the left encoder, and Limiter Profile to the right encoder.

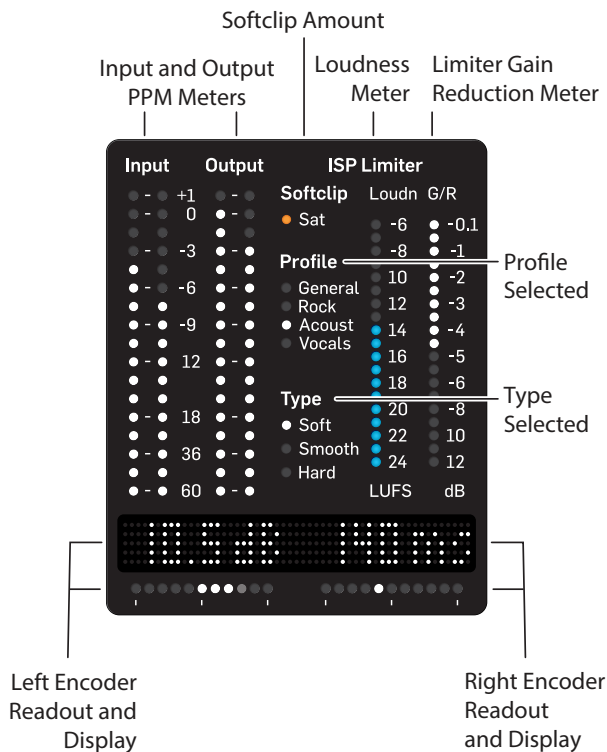

7.1.7 Soft Clip/Type

Selecting the Soft Clip/Type button will assign Soft Clip Threshold to the left encoder, and Soft Clip Type to the right encoder.

See the details below for the Loudness Limiter Set Gain procedure using the Desktop Controller.

7.1.8 Preset

Press the Preset button to enable preset browsing using the encoders. Either of the encoders will browse to new presets, and while browsing, the Preset LED will blink. Once a desired preset number is reached, the preset can be loaded by pressing the Preset button again, and the button LED stops blinking. A modified (edited) preset is marked "xx." in the module display.

Note: It is possible to browse all the presets, or to browse just the favorite presets only. The selection of which of these approaches to use, is done in the plugin.

7.2 Set Gain procedure using the optional Desktop Controller

With Loudness Limiter selected, holding Loudness Limiter (labeled Loudn) will start the Set Gain procedure. This will automatically set the Limiter Gain behind the scenes, based on the audio content and your Loudness Target.

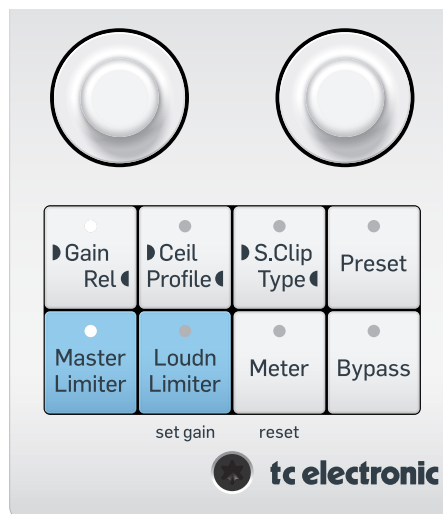

1. Make sure you have set the Target Loudness level, say -15 LUFS. The Spotify/Apple/AES Stream texts will individually light up if your Loudness target is appropriate for these platforms. Note that these recommendations are bound to change now and then. To see the latest evolution, please refer to <https://finalizer.com/analyzer>
2. Start DAW playback of your project or track, and hold Loudness Limiter to let BRICKWALL HD listen to the content. The Loudness Limiter button will blink while the text display reads LIST. (Listening) and shows the accumulated Loudness value while sampling the content. The Loudness bar in the display will also show the accumulated Loudness value. The LED bar increases 1 LED per second during Listening.
3. When the Loudness measurement in the display is not evolving anymore, or when the plug-in reads "Sample OK" (when this happens the LED bar on the Desktop Controller will not blink anymore), you may press Loudness Limiter to stop listening. The display will flash "DONE".
4. Now, the measured input loudness and the adjusted Target Loudness are used to set the Gain behind the scenes, which will result in the Limiter working to aim for the Target Loudness.

Please note:

- We recommend that you let the BRICKWALL HD listen to multiple passages, especially the loudest in your track, to help the BRICKWALL HD "hit the target" optimally
- The BRICKWALL HD Desktop Controller will show different messages if the Set Gain-feature is not able to find appropriate settings due to the sample being too short, too low audio level, no audio detected etc.

8. Presets

The BRICKWALL HD offers a collection of factory presets, as well as the option to create and save your own custom settings as user presets and favourites.

Note that most DAWs have a built-in preset function that appears on every plug-in, which is often found at the top of the plug-in window.

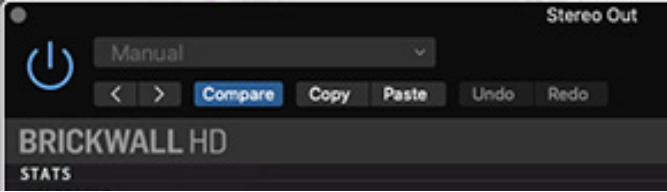

It is not recommended to use this as your primary method of saving presets, as it has limited functionality and does not allow the saved presets to be transferred easily to other DAWs. Instead, we suggest using the Preset section at the bottom right corner of the user interface window:



A single click on this PRESET window will bring up a menu with several preset-related options. You can recall a factory or user preset from the libraries, save the current preset, or create a new user preset with the 'Save as' option.

The presets menu is divided into Factory Presets and User Presets.

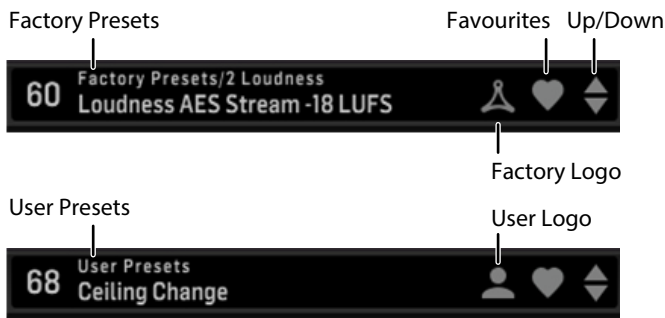
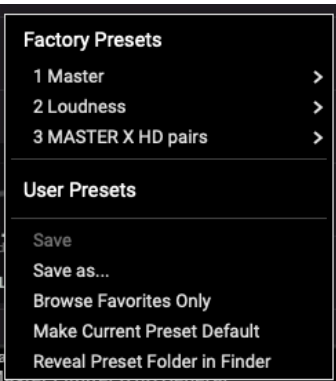

8.1 Factory Presets

Factory presets are built into the plug-in and cannot be overwritten.



The factory presets have three main options:

- Master presets: for when the BRICKWALL is used as with the Master Limiter approach
- Loudness presets: for when the BRICKWALL HD is used with the Loudness Limiter approach
- MASTER X HD Pairs: for when the BRICKWALL HD is used in conjunction with the MASTER X HD Plug-in. The MASTER X HD has similar presets

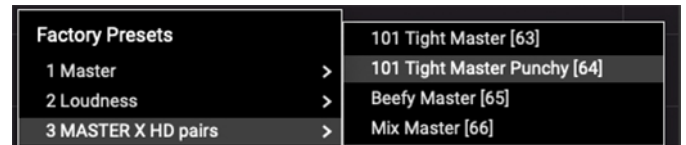

When recalling a Factory preset or saved User preset, the name will appear in plain text as shown below.



8.2 User Presets

If you make an alteration to any of the parameters in the current preset, the preset name changes to *italics* as a reminder that something has changed from the original factory preset.



To save this new setting as a User preset, click in the PRESET window, then select the Save As option. Save it with an appropriate name. User presets can be edited and organized as you like.

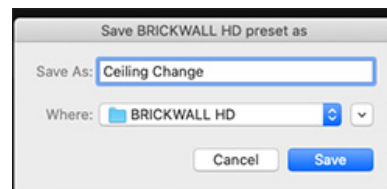
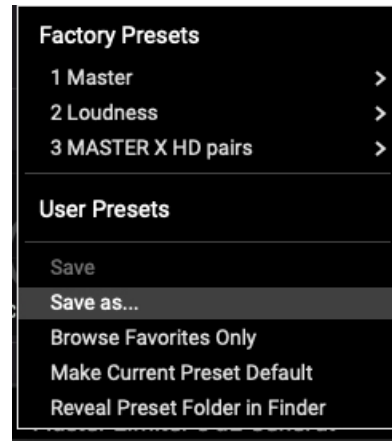

To discard the changes without saving, simply navigate away from that preset.

The altered preset will be saved as a user preset, with your new name for it, and its name will appear in the User Presets window.



If you modify a saved user preset, you have the option to "Save" (rewriting over the existing user preset) or "Save As" (save as a new user preset).

If you modify a factory preset, then only "Save As" is available (to save as a new user preset). Factory presets cannot be overwritten.

User presets are not given a number unless you first assign them as favourites. (See Favourite Presets below.)

8.3 Favorite Presets

Creating your own presets will make them accessible from the Preset menu, but they will only appear in the list of 100 presets in the plug-in or hardware unit if you set them as a favorite. This is done by assigning a favorite slot number to the preset using the Favorite menu.

Click the FAVORITE (heart-shaped) button in the preset window, then select one of the 10 banks. Assign one of your custom presets to a favorite slot, then save the preset. When a preset is set as a favorite, the "heart" logo will be filled.

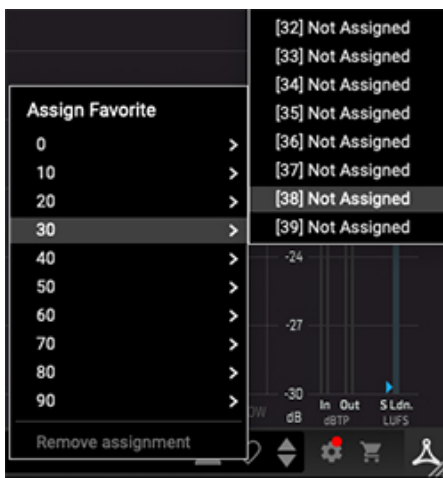

When a preset is assigned a favorite slot number:

- The preset is part of the 100 presets that can be recalled on the hardware unit
- The favorite number will be displayed on the hardware unit when recalled
- The favorite number will be locked so that two presets cannot be assigned to the same favorite slot number. This is shown in the Favorite menu by graying out the number in question.
- The favorite number will be displayed in brackets when you browse the presets menu

You can remove the favorite assignment by selecting the "Remove Assignment" feature in the Favorite menu, then saving the preset.

8.4 Browse Favorites Only

The 'Browse Favorites Only' option in the preset menu allows the UP/DOWN arrows in the bottom bar of the plug-in, or via the hardware unit, to scroll only through the favorites list. Otherwise, scrolling goes through all presets.

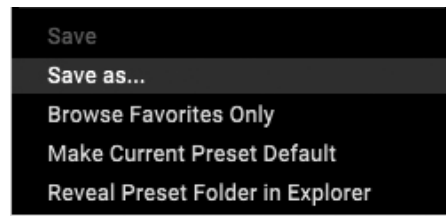

8.5 Make Current Preset Default

Selecting 'Make current preset default' will cause this preset to appear every time a new instance of the plug-in is created.

8.6 Reveal User Preset Folder in Explorer

To change the name of a preset, select 'Reveal User Preset Folder in Explorer' and modify the file name. This will open a Finder (Mac) or Explorer (PC) window where the user presets are stored. You can rename as well as delete, copy and paste presets. This allows you to share presets with other users online, simply pasting the new ones in this folder.

8.7 Presets and the optional Desktop Controller

Presets can also be recalled from the hardware unit by pressing the PRESET button.

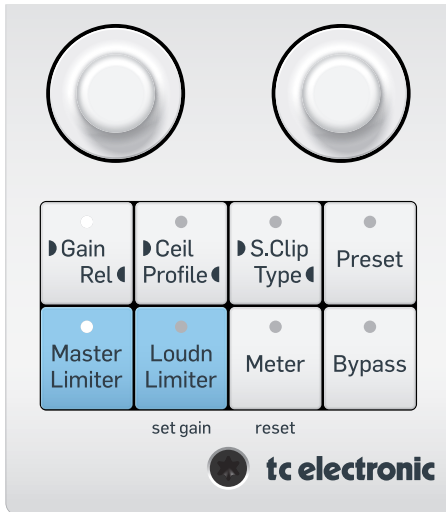

Rotate the hardware knob to scroll through presets one slot at a time, or use your computer's keyboard to enter a specific preset number, followed by the ENTER button.

9. Software Updates

New versions of the software may be released to add new features and improve performance. Updates can be detected from the plug-in directly and can be installed after download from the website. See Chapter 2 for plug-in installation.

If the 'Automatically check for updates' option is checked inside the update menu, the red dot will appear on the settings icon when a new plug-in is available.

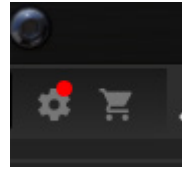

Click the gear icon and select "Check for Updates" to perform a scan.

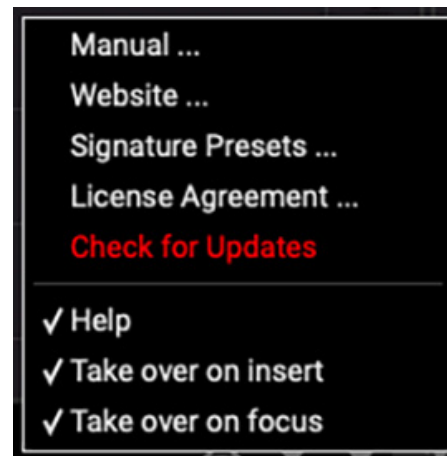

9.1 Hardware Unit Software Updates (optional)

The hardware unit firmware will be included in each plug-in update.

After you have installed a new plug-in, the system will detect mismatched firmware and indicate a need for update via a small red dot on the gear icon.

Click the "Upgrade to x.x.xx" field to start the update. Progress will be indicated in the plug-in, and the Feedback LED on the hardware unit will flash. (This example shows a TC2290 plug-in.)

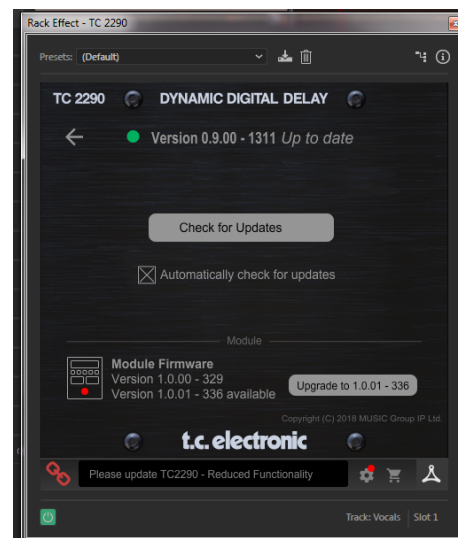

10. Specifications

Sound

Processing	True-Peak limiter. Master and Loudness variants
Sample rates	44.1, 48, 88.2, 96, 176.4, 192 kHz

Software Support

Operating systems	Mac OS X 10.13 Sierra or above, Windows 7 or above
Drivers	No additional drivers required, uses standard USB HID drivers
Plugin formats	AAX-native, Audio Units, VST2.4, VST3. 64 bit

USB Connection (DT version)

Type	USB 2.0, type micro-B
------	-----------------------

Power (DT version)

Power supply	USB bus powered
Power consumption	Max. 2.5 W

Physical (DT version)

Dimensions (HxWxD)	42 x 54 x 135 mm (1.7 x 2.1 x 5.3")
Weight	0.19 kg (0.42 lbs)

Note: Operation Ambient Temperature up to 45°C

FEDERAL COMMUNICATIONS COMMISSION COMPLIANCE INFORMATION

TC Electronic

BRICKWALL HD DT

Responsible Party Name: **Music Tribe Commercial NV Inc.**

Address: **901 Grier Drive
Las Vegas, NV 89118
USA**

Phone Number: **+1 747 237 5033**

BRICKWALL HD DT

This equipment has been tested and found to comply with the limits for a Class B digital device, pursuant to part 15 of the FCC Rules. These limits are designed to provide reasonable protection against harmful interference in a residential installation. This equipment generates, uses and can radiate radio frequency energy and, if not installed and used in accordance with the instructions, may cause harmful interference to radio communications. However, there is no guarantee that interference will not occur in a particular installation. If this equipment does cause harmful interference to radio or television reception, which can be determined by turning the equipment off and on, the user is encouraged to try to correct the interference by one or more of the following measures:

- Reorient or relocate the receiving antenna.
- Increase the separation between the equipment and receiver.
- Connect the equipment into an outlet on a circuit different from that to which the receiver is connected.
- Consult the dealer or an experienced radio/TV technician for help.

This device complies with Part 15 of the FCC rules. Operation is subject to the following two conditions:

- (1) this device may not cause harmful interference, and
- (2) this device must accept any interference received, including interference that may cause undesired operation.

Important information:

Changes or modifications to the equipment not expressly approved by Music Tribe can void the user's authority to use the equipment.

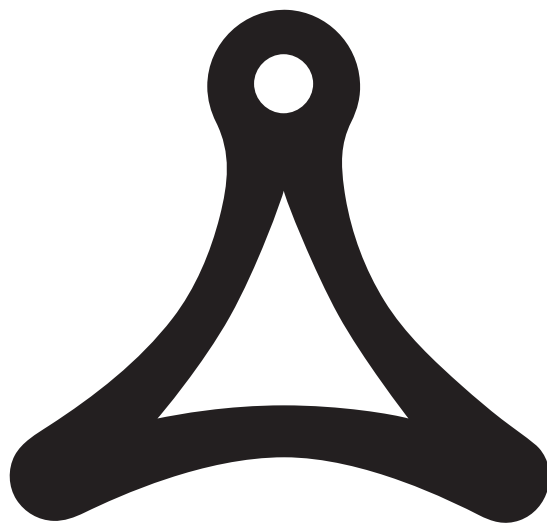

TC ICON
S E R I E S