

FR 9.15 - 4 Ohm

Art. No. 2054



9 x 15 cm (4" x 6") Breitbandlautsprecher. Ausgeglichener Frequenzgang, deshalb für Sprach- und Musikwiedergabe z.B. in Fahrzeugen besonders gut geeignet. Geringe Einbautiefe.

9 x 15 cm (4" x 6") full-range driver. Well-balanced frequency response makes this speaker ideal for both voice and music reproduction e.g. extremely well suited to use in vehicles. Minimum depth required.

Anwendungsmöglichkeiten / Typical applications

- Straßen- und Schienenfahrzeuge (z.B. Wohnmobile, Straßenbahnen etc.)

- Vehicles of all types (road or rail), e.g. mobile homes, trams etc.

22.07.2013

Eigenschaften / Attributes

- Feuchtigkeitsimprägnierte Membran
- Metallausführung

- Moisturised cone
- Metal basket

FR 9.15 - 4 Ohm

Art. No. 2054

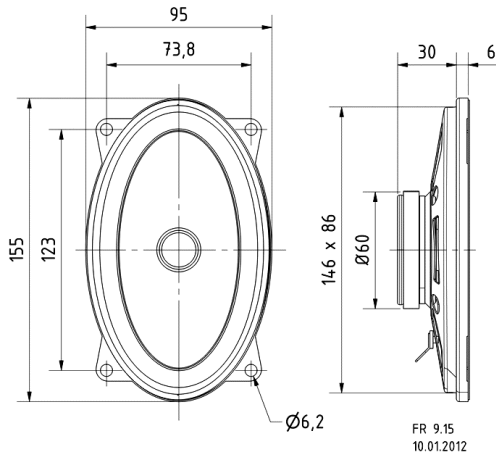

Technische Daten / Technical data

Nennbelastbarkeit Rated power	15 W
Musikbelastbarkeit Maximum power	30 W
Nennimpedanz Z Nominal impedance Z	4 Ohm
Übertragungsbereich Frequency response	75–16000 Hz
Mittlerer Schalldruckpegel Mean sound pressure level	85 dB (1 W/1 m)
Abstrahlwinkel (-6 dB) Opening angle (-6 dB)	147°/4000 Hz hor. 180°/4000 Hz ver.
Grenzauslenkung Excursion limit	+/-1,5 mm
Resonanzfrequenz fs Resonance frequency fs	120 Hz
Magnetische Induktion Magnetic induction	0,9 T
Magnetischer Fluss Magnetic flux	170 μWb
Obere Polplattenhöhe Height of front pole-plate	3 mm
Schwingspulendurchmesser Voice coil diameter	20 mm
Wickelhöhe Height of winding	5 mm
Schallwandöffnung Cutout diameter	146 x 87 mm (oval)
Gewicht netto Net weight	0,277 kg
Gleichstromwiderstand Rdc D.C. resistance Rdc	3,5 Ohm
Mechanischer Q-Faktor Qms Mechanical Q factor Qms	8,90
Elektrischer Q-Faktor Qes Electrical Q factor Qes	2,29
Gesamt-Q-Faktor Qts Total Q factor Qts	1,82
Äquivalentes Luftnachgiebigkeitsvolumen Vas Equivalent volume Vas	2,9 l
Effektive Membranfläche Sd	

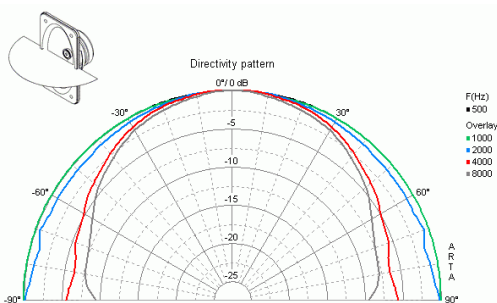
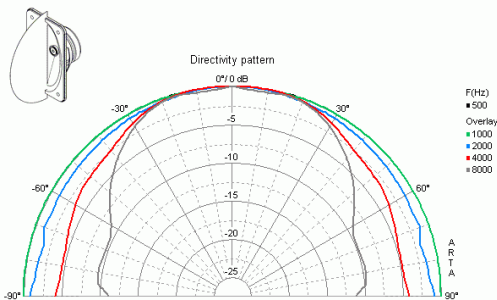

22.07.2013

Effective piston area Sd	79 cm ²
Dynamische bewegte Masse Mms Dynamically moved mass Mms	4,6 g
Antriebsfaktor Bxl Force factor Bxl	2,3 Tm
Schwingspuleninduktivität L Inductance of the voice coil L	0,3 mH
Anschlüsse Connections	4,8 x 0,8 mm (+) 2,8 x 0,8 mm (-)
Temperaturbereich Temperature range	-25 ... 70 °C